

***Buck chopper
Trench IGBT® Power Module***

**$V_{CES} = 1700V$
 $I_C = 30A @ T_c = 80^\circ C$**

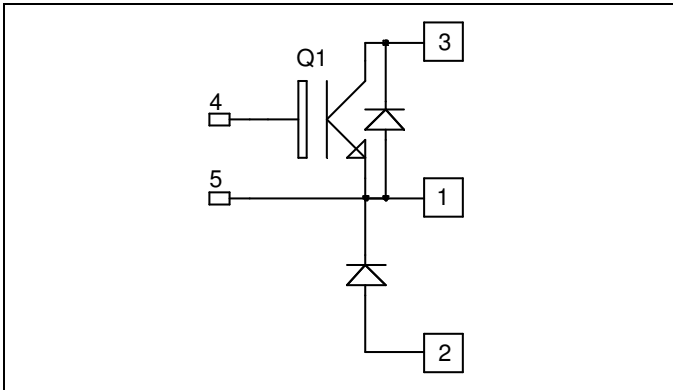

Application

- AC and DC motor control
- Switched Mode Power Supplies

Features

- Trench + Field Stop IGBT® Technology
 - Low voltage drop
 - Low tail current
 - Switching frequency up to 20 kHz
 - Soft recovery parallel diodes
 - Low diode VF
 - Low leakage current
 - Avalanche energy rated
 - RBSOA and SCSOA rated
- Kelvin emitter for easy drive
- Low stray inductance
- High level of integration
- Kelvin emitter for easy drive
- Low stray inductance
 - M5 power connectors

Benefits

- Stable temperature behavior
- Very rugged
- Direct mounting to heatsink (isolated package)
- Low junction to case thermal resistance
- Easy paralleling due to positive TC of VCEsat

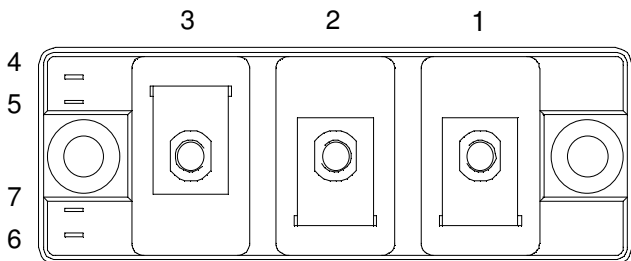

Absolute maximum ratings

Symbol	Parameter	Max ratings	Unit
V_{CES}	Collector - Emitter Breakdown Voltage	1700	V
I_C	Continuous Collector Current	$T_C = 25^\circ C$	45
		$T_C = 80^\circ C$	30
I_{CM}	Pulsed Collector Current	$T_C = 25^\circ C$	70
V_{GE}	Gate - Emitter Voltage	± 20	V
P_D	Maximum Power Dissipation	$T_C = 25^\circ C$	210
RBSOA	Reverse Bias Safe Operation Area	$T_j = 125^\circ C$	70A@1700V

CAUTION: These Devices are sensitive to Electrostatic Discharge. Proper Handling Procedures Should Be Followed.

All ratings @ $T_j = 25^\circ\text{C}$ unless otherwise specified

Electrical Characteristics

Symbol	Characteristic	Test Conditions	Min	Typ	Max	Unit
BV_{CES}	Collector - Emitter Breakdown Voltage	$V_{GE} = 0V, I_C = 1.5mA$	1700			V
I_{CES}	Zero Gate Voltage Collector Current	$V_{GE} = 0V, V_{CE} = 1700V$			3	mA
$V_{CE(on)}$	Collector Emitter on Voltage	$V_{GE} = 15V$ $I_C = 30A$		$T_j = 25^\circ\text{C}$ $T_j = 125^\circ\text{C}$	2.0 2.4	V
$V_{GE(th)}$	Gate Threshold Voltage	$V_{GE} = V_{CE}, I_C = 1.5mA$	5.2	5.8	6.4	V
I_{GES}	Gate - Emitter Leakage Current	$V_{GE} = 20V, V_{CE} = 0V$			600	nA

Dynamic Characteristics

Symbol	Characteristic	Test Conditions	Min	Typ	Max	Unit
C_{ies}	Input Capacitance	$V_{GE} = 0V, V_{CE} = 25V$		2500		pF
C_{res}	Reverse Transfer Capacitance	$f = 1MHz$		90		
$T_{d(on)}$	Turn-on Delay Time	Inductive Switching (25°C) $V_{GE} = \pm 15V$ $V_{Bus} = 900V$ $I_C = 30A$ $R_G = 18\Omega$		200		ns
T_r	Rise Time			100		
$T_{d(off)}$	Turn-off Delay Time			750		
T_f	Fall Time			90		
$T_{d(on)}$	Turn-on Delay Time	Inductive Switching (125°C) $V_{GE} = \pm 15V$ $V_{Bus} = 900V$ $I_C = 30A$ $R_G = 18\Omega$		230		ns
T_r	Rise Time			100		
$T_{d(off)}$	Turn-off Delay Time			850		
T_f	Fall Time			115		
E_{off}	Turn Off Energy			22		mJ

Reverse diode ratings and characteristics

Symbol	Characteristic	Test Conditions	Min	Typ	Max	Unit
V_F	Diode Forward Voltage	$I_F = 50A$ $V_{GE} = 0V$		$T_j = 25^\circ\text{C}$ $T_j = 125^\circ\text{C}$	1.8 1.9	2.2 V
E_r	Reverse Recovery Energy	$I_F = 50A$ $V_R = 900V$ $di/dt = 990A/\mu s$		$T_j = 25^\circ\text{C}$ $T_j = 125^\circ\text{C}$	8 15	mJ
Q_{rr}	Reverse Recovery Charge	$I_F = 50A$ $V_R = 900V$ $di/dt = 990A/\mu s$		$T_j = 25^\circ\text{C}$ $T_j = 125^\circ\text{C}$	18 29	μC

Thermal and package characteristics

Symbol	Characteristic	Min	Typ	Max	Unit	
R_{thJC}	Junction to Case	IGBT			0.6	$^\circ\text{C}/W$
		Diode			0.9	
V_{ISOL}	RMS Isolation Voltage, any terminal to case $t = 1$ min, $I_{isol} < 1mA, 50/60Hz$	3500			V	
T_j	Operating junction temperature range	-40		150	$^\circ\text{C}$	
T_{STG}	Storage Temperature Range	-40		125		
T_C	Operating Case Temperature	-40		125		
Torque	Mounting torque	For terminals	M5	2	3.5	N.m
		To Heatsink	M6	3	5	
Wt	Package Weight			180	g	

Package outline

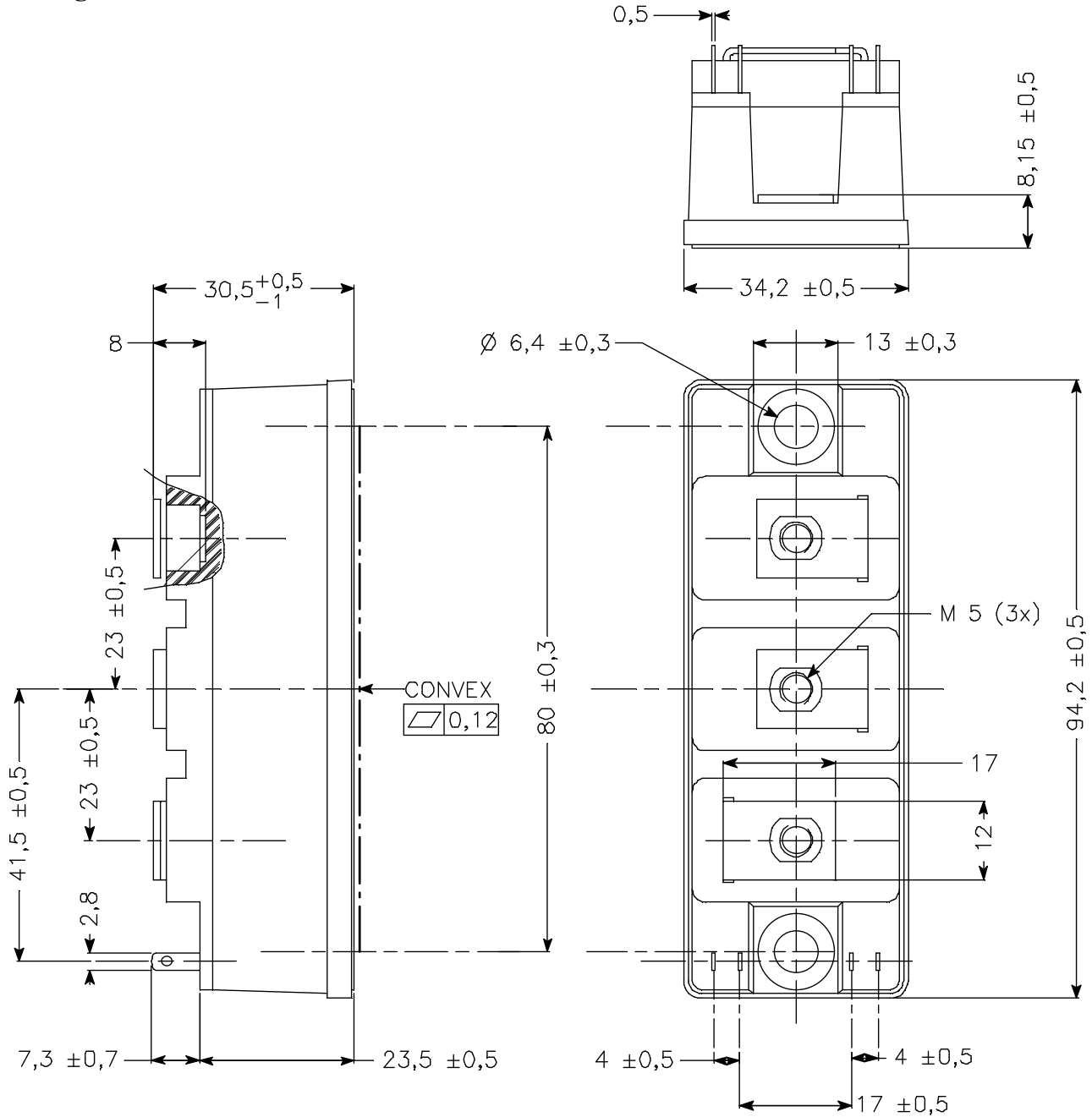

APT reserves the right to change, without notice, the specifications and information contained herein

APT's products are covered by one or more of U.S patents 4,895,810 5,045,903 5,089,434 5,182,234 5,019,522 5,262,336 6,503,786 5,256,583 4,748,103 5,283,202 5,231,474 5,434,095 5,528,058 and foreign patents. U.S and Foreign patents pending. All Rights Reserved.