



MAX II Development Kit

Getting Started User Guide



101 Innovation Drive
San Jose, CA 95134
(408) 544-7000
www.altera.com
P25-10351-01

Development Kit Version: 1.1.0
Document Version: 1.1.0
Document Date: July 2005

Copyright © 2005 Altera Corporation. All rights reserved. Altera, The Programmable Solutions Company, the stylized Altera logo, specific device designations, and all other words and logos that are identified as trademarks and/or service marks are, unless noted otherwise, the trademarks and service marks of Altera Corporation in the U.S. and other countries. All other product or service names are the property of their respective holders. Altera products are protected under numerous U.S. and foreign patents and pending applications, maskwork rights, and copyrights. Altera warrants performance of its semiconductor products to current specifications in accordance with Altera's standard warranty, but reserves the right to make changes to any products and services at any time without notice. Altera assumes no responsibility or liability arising out of the application or use of any information, product, or service described herein except as expressly agreed to in writing by Altera Corporation. Altera customers are advised to obtain the latest version of device specifications before relying on any published information and before placing orders for products or services.



UG-M292904-1.1



About This User Guide

Revision History	v
How to Contact Altera	v
Typographic Conventions	vi

Chapter 1. About This Kit

Features	1-1
----------------	-----

Chapter 2. Getting Started

System Requirements	2-1
MAX II Development Kit Contents	2-1
Inspect the Board	2-1
Software Requirements	2-1
Important Considerations	2-2
Installing the MegaCore Function & Reference Designs/Demos	2-2
Installing the Quartus II Software	2-3
Quartus II System Requirements	2-3
Setting Up Licensing	2-3
Connecting the Cables and Power to the Board & PC	2-4
ByteBlaster II Cable	2-4
Programming the MAX II Device	2-4
Running the Functional Test	2-6
Demo Designs	2-7
Power-Up Time Demonstration	2-7
Low Power Demonstration	2-12
Real-Time ISP Demonstration	2-14
Reference Designs	2-16
Reference Design 1: USB Reference Design	2-16
Reference Design 2: The Slot Game Reference Design	2-22
Reference Design 3: PCI Reference Design	2-26



About This User Guide

Revision History

The table below displays the revision history for chapters in this user guide.

Chapter	Date	Version	Changes Made
All	October 2004	1.0.0	First release of User Guide
All	July 2005	1.1.0	Minor updates



Refer to the readme file on the *MAX II Development Kit CD-ROM* for late-breaking information that is not available in this user guide.







How to Contact Altera

For technical support or other information about Altera® products, go to the Altera world-wide web site at www.altera.com. You can also contact Altera through your local sales representative or any of the sources listed below.

Information Type	USA & Canada	All Other Locations
Technical support	www.altera.com/mysupport/	www.altera.com/mysupport/
	800-800-EPLD (3753) 7:00 a.m. to 5:00 p.m. Pacific Time	+1 408-544-8767 7:00 a.m. to 5:00 p.m. (GMT -8:00) Pacific Time
Product literature	www.altera.com	www.altera.com
Altera literature services	literature@altera.com	literature@altera.com
Non-technical customer service	800-767-3753	+ 1 408-544-7000 7:00 a.m. to 5:00 p.m. (GMT -8:00) Pacific Time
FTP site	ftp.altera.com	ftp.altera.com

Typographic Conventions

This document uses the typographic conventions shown below.

Visual Cue	Meaning
Bold Type with Initial Capital Letters	Command names, dialog box titles, checkbox options, and dialog box options are shown in bold, initial capital letters. Example: Save As dialog box.
bold type	External timing parameters, directory names, project names, disk drive names, filenames, filename extensions, and software utility names are shown in bold type. Examples: f_{MAX} , iqdesigns directory, d: drive, chiptrip.gdf file.
<i>Italic Type with Initial Capital Letters</i>	Document titles are shown in italic type with initial capital letters. Example: <i>AN 75: High-Speed Board Design</i> .
<i>Italic type</i>	Internal timing parameters and variables are shown in italic type. Examples: <i>t_{PIA}</i> , <i>n + 1</i> . Variable names are enclosed in angle brackets (< >) and shown in italic type. Example: <file name>, <project name>.pdf file.
Initial Capital Letters	Keyboard keys and menu names are shown with initial capital letters. Examples: Delete key, the Options menu.
“Subheading Title”	References to sections within a document and titles of on-line help topics are shown in quotation marks. Example: “Typographic Conventions.”
Courier type	Signal and port names are shown in lowercase Courier type. Examples: data1, tdi, input. Active-low signals are denoted by suffix n, e.g., resetn. Anything that must be typed exactly as it appears is shown in Courier type. For example: c:\qdesigns\tutorial\chiptrip.gdf. Also, sections of an actual file, such as a Report File, references to parts of files (e.g., the AHDL keyword SUBDESIGN), as well as logic function names (e.g., TRI) are shown in Courier.
1., 2., 3., and a., b., c., etc.	Numbered steps are used in a list of items when the sequence of the items is important, such as the steps listed in a procedure.
	Bullets are used in a list of items when the sequence of the items is not important.
	The checkmark indicates a procedure that consists of one step only.
	The hand points to information that requires special attention.
	The caution indicates required information that needs special consideration and understanding and should be read prior to starting or continuing with the procedure or process.
	The warning indicates information that should be read prior to starting or continuing the procedure or processes
	The angled arrow indicates you should press the Enter key.
	The feet direct you to more information on a particular topic.

The MAX[®] II Development Kit provides everything you need to develop complete solutions using MAX II devices. Several demos and reference designs are included to show some of the features and benefits of MAX II CPLD devices, as well as provide a starting point for custom designs. This document describes how to install the software provided with the kit and how to use the demos and reference designs that accompany the MAX II development board.

Features

The MAX II Development Kit includes:

- *MAX II Development Board*—The MAX II development board is a prototyping and evaluation platform that provides designers with an easy way to assess the features of the MAX II device and to begin building custom solutions with the MAX II device. Key features of the board include an EPM1270 device along with current sense circuitry, power-up time detection circuitry, SRAM, and an LCD. Refer to the *MAX II EPM1270 Development Board Data Sheet* for more information.
- *Quartus[®] II Development Software, Web Edition*—The Quartus II development software provides a comprehensive environment for SOPC design. The Quartus II software integrates into nearly any design environment, with interfaces to industry-standard EDA tools. You can obtain a 4-month license for the software from the Altera[®] web site. The Quartus II license allows you to use the product for four months only. After four months, you must get a renewal to keep on using the software.
- *MegaCore[®] IP Functions*—The kit contains the Altera `pci_t32` MegaCore function with the OpenCore[®] Plus feature. This OpenCore Plus feature lets you quickly and easily verify the IP function by running a time-limited version in hardware before making a purchase decision. The OpenCore Plus hardware evaluation feature is an evaluation tool for prototyping only. You must purchase a license to use an Altera MegaCore in production designs.

- *Reference Designs/Demos*—Altera provides several demos and reference designs with the MAX II Development Kit to help you get started building applications. See “[Demo Designs](#)” on page 2–7 and “[Reference Designs](#)” on page 2–16 for more information on the designs provided.

System Requirements

Before using the kit or installing the software, be sure to check the contents of the kit and inspect the board to verify that you received all of the items. If any of these items are missing, contact Altera® before you proceed. You should also verify that your PC meets the software and system requirements of the kit.

MAX II Development Kit Contents

The MAX® II Development Kit contains the following items:

- MAX II development board with an EPM1270 device
- ByteBlaster™ II Programming cable
- USB Type A-B cable
- *MAX II Development Kit CD-ROM*
- *Quartus® II Development Software Web Edition CD-ROM*

Inspect the Board



The MAX II development board can be damaged without proper anti-static handling.

Place the board on an anti-static surface and inspect it to ensure that it has not been damaged during shipment. Verify that all components are on the board and appear intact. Note that some components are purposefully unpopulated. There are several resistors that are unpopulated, as well as an EEPROM socket (J10).



Refer to the *MAX II EPM1270 Development Board Data Sheet* (available on the *MAX II Development Kit CD-ROM*) for information on the board components and their locations.

Software Requirements

You should install the following software before you begin developing designs for the kit:

- Internet Explorer 4.01 with Service Pack 2 or later to use Quartus II Help. You need a web browser to register the Quartus II software and request license files.

- Altera recommends that you install the software that is on the *MAX II Development Kit CD-ROM*. See “Installing the MegaCore Function & Reference Designs/Demos”.
- Quartus II software version 4.1 SP1 or later. See “Installing the Quartus II Software”.

Important Considerations

You need your network identification card (NIC) ID for licensing the Quartus II software.

Your NIC number is a 12-digit hexadecimal number that identifies the Windows NT workstation that serves Quartus II licenses. Networked (or floating node) licensing requires an NIC number or server host ID. When obtaining a license file for network licensing, you should use the NIC number from the PC that will issue the Quartus II licenses to distributed users over a network. You can find the NIC number for your card by typing `ipconfig /all` at a command prompt. Your NIC number is the number on the physical address line, without the dashes.

You need administrative privileges to install the required software.

Installing the MegaCore Function & Reference Designs/Demos

To install the MegaCore® functions and reference designs, insert the *MAX II Development Kit CD-ROM* into your CD-ROM drive. Copy the files to your hard drive.



The `pci_t32` MegaCore function installer is available in the `<root>/Examples/HW/ReferenceDesigns/PCI_ReferenceDesign/PCI_Megacore_Installer` directory. To take advantage of the evaluation version of this MegaCore, install it in the directory of your choice.

Figure 2-1 shows the directory structure.

Figure 2–1. MAX II Directory Structure

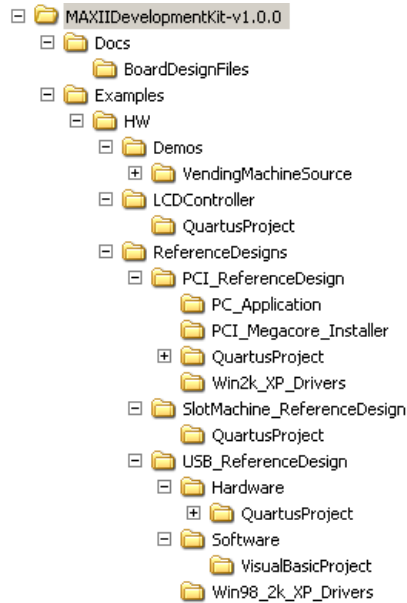

Installing the Quartus II Software

Refer to “Installing the Quartus II Software” in the *Quartus II Installation & Licensing Manual for PCs*, which is included on the *MAX II Development Kit CD-ROM*, for the software installation instructions. After the software finishes installing, you must request and install a license to enable it. See “Setting Up Licensing” on page 2–3 for more information.

Quartus II System Requirements

To use the MAX II Development Kit with the Quartus II software provided with the kit, your system must meet the Quartus II software minimum requirements. Refer to “System Requirements” in the *Quartus II Installation & Licensing Manual for PCs*, which is included on the *MAX II Development Kit CD-ROM*, for the software requirements.

Setting Up Licensing

Before using the Quartus II software, you must request a license file from the Altera web site at www.altera.com/licensing and install it on your PC. When you request a license file, Altera e-mails you a **license.dat** file that enables the software. To obtain a license, perform the following steps:

1. Log on to the Altera web site at www.altera.com/licensing.

2. Click **Quartus II Web Edition Software**.
3. Follow the on-line instructions to request your license. A license file is e-mailed to you.
4. To install your license, refer to “Specifying the License File” in the *Quartus II Installation & Licensing Manual for PCs*, included on the *MAX II Development Kit CD-ROM*.

Connecting the Cables and Power to the Board & PC

The MAX II Development Board obtains power from either the USB or PCI interfaces. The three-pin jumper J8 controls whether power is obtained via USB or PCI. The board ships with the power control option set to USB (the shunt on J8 connects pins 1-2). To power the board from the PCI Edge Connector, the shunt should be moved to pins 2-3.

To use the board outside of a PC chassis, you must connect the USB Type A-B cable (included with the kit) from your PC to the board. The first time you connect to your PC, the operating system will notify you that it “Found New Hardware.” Windows XP automatically installs drivers for you, while Windows NT and Windows 98 do not. The drivers are only necessary if you are planning to use your PC to transfer data to and from the MAX II development board. For more information, refer to [“Reference Design 1: USB Reference Design”](#) on page 2–16.

ByteBlaster II Cable

The ByteBlaster II cable is used to download new programming files to the MAX II device. The board supplies power to the ByteBlaster II download cable. Connect the ByteBlaster II cable’s 10-pin female plug to the MAX II device JTAG header on the board (J2) and connect the other end to your PC to configure the MAX II device directly using a POF file.



Align the ByteBlaster II connector so that the red strip is orientated towards the Altera logo on the board.

Programming the MAX II Device

In order to program the MAX II device on the MAX II development board, you must provide power to the board. The MAX II development board can be powered via the USB or PCI interfaces. This section assumes the board is being powered via USB. Refer to [“Reference Design 3: PCI Reference Design”](#) on page 2–26 for details regarding programming when the PCI bus is supplying power.

Set Up the MAX II Development Board for Programming

1. Make sure the shunt on jumper J8 is connected to pins 1 and 2 (the two pins closest to the LCD on the board). This supplies power from the USB cable to the board power plane.
2. Connect the USB cable from the USB port on your PC to the USB Type B connector on the MAX II development board.
3. Connect the ByteBlaster II cable from the parallel port of your PC to the MAX II board header J2.



The red stripe on the ByteBlaster cable indicates the side that pin 1 is on.

Set Up the Quartus II Software for Programming

4. Launch Quartus II and select **Open** (File menu).
5. In the **Open** dialog box set the **Files of Type** field to **Programming Files (*.cdf, *.sof, *.pof, *.jam, *.jbc)**.
6. Browse to the location of the POF file you want to load into the MAX II device and open it.
7. Turn on the three check boxes in the **Program/Configure** and **Verify** columns. See [Figure 2-2](#).



Note that the CFM refers to the Configuration Flash Memory—this is the non-volatile portion of the MAX II device that stores the configuration data and loads it into the logic portion of the MAX II device. The UFM refers to the User Flash Memory on the MAX II device. This is 8 Kbits of non-volatile user storage space. For more information on the MAX II device, the UFM, and the CFM, refer to the *MAX II Device Handbook*.

8. Ensure that the **Hardware setup** box lists the ByteBlaster II cable in the box. If it doesn't, click **Hardware Setup** and select the ByteBlaster II cable (you may have to add it using the **Add** button before you can select it). Refer to the Quartus Help menu for assistance in setting up the programming hardware.
9. Click **Start** to program the device.

Figure 2–2. Programmer Window Dialog Box

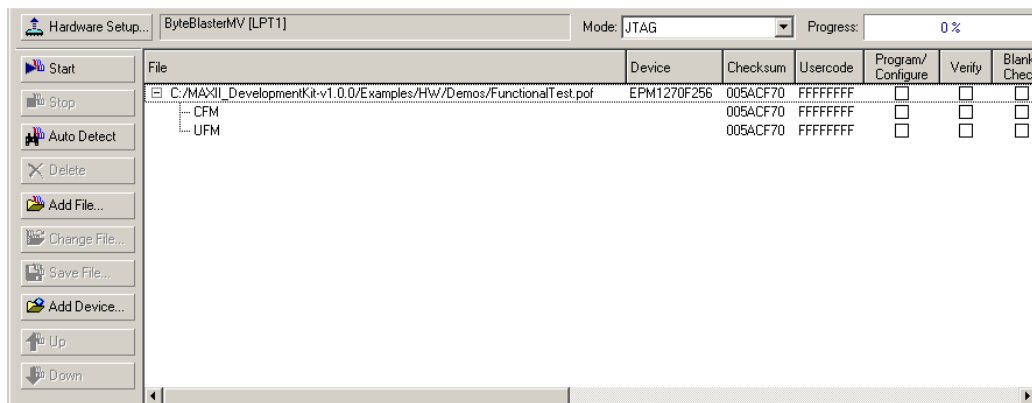

Running the Functional Test

The Functional Test is a simple design that exercises each component on the board to ensure that the board is functioning properly. These tests are run at the factory before the boards are shipped. They are provided to the user so the board’s functionality can be verified at any time during the life of the board.

To run the tests do the following:

1. Program the board with **FunctionalTest.pof**, located in the `<root>/Examples/HW/Demos` directory. (Refer to “[Programming the MAX II Device](#)” on page 2–4 for details on how to load POF files into the MAX II device.)
2. The LCD should read “MAX II by Altera”.
3. Push S2 to cycle through the tests.
 - a. After pressing S2 once, the LCD screen should display the voltage of V_{CCINT} . MAX II V_{CCINT} can be set to 2.5 V or 3.3 V. You can test this feature by placing a shunt on J9. If the shunt is present, the voltage displayed on the LCD should be about 2.5 V; if the shunt is removed, the voltage displayed should be 3.3 V.
 - b. Pressing S2 a second time will display the value of I_{INT} .
 - c. Pressing S2 a third time will display the value of the V_{CCIO} , which should be ~3.3 V.

- d. Pressing S2 a fourth time will display the value of I_{IO} .
- e. Pressing S2 a fifth time will display the board temperature, which should be between 18° C and 23° C, depending on your room temperature.
- f. Pressing S2 a sixth time will display the LED test—LEDs 1-4 should light up and turn off one at a time.
- g. Pressing S2 a seventh time will display the SRAM test—the LCD will indicate Pass or Fail.
- h. Pressing S2 for the eighth time will display the LCD test—note the text: “LCD Does Work!”
- i. Pressing S2 for the ninth time returns to the start up screen. The LCD display reads: “MAX II by Altera”

If all tests pass, the MAX II development board is ready to use.

Altera provides several demos and reference designs with the MAX II Development Kit to help you get started building applications and to demonstrate the features of the MAX II device. The next two sections describe the functionality of these designs.

Demo Designs

The MAX II Development Kit includes three demos that illustrate features of the MAX II device:

- “Power-Up Time Demonstration”
- “Low Power Demonstration”
- “Real-Time ISP Demonstration”

Power-Up Time Demonstration

MAX II devices power up and configure very quickly and may be used to perform vital power-up functions. In order to allow users to investigate the fast power-up time of a MAX II device, the board is equipped with a circuit that allows users to observe the time it takes for a MAX II device to power up under a variety of different power supply loading conditions. This circuit allows users to increase or decrease the load on the V_{CCINT} voltage plane. As this load is increased, the ramp time (or slew rate) of the MAX II V_{CCINT} voltage increases. Using this circuit you can mimic the load that the MAX II device’s V_{CCINT} voltage plane will have on a custom piece of hardware. This knowledge allows you to verify that the MAX II device will be powered up and configured quickly enough to perform whatever power up functions are required in the user system.



This test is meant to verify the data provided in the *MAX II Device Data Sheet*, not to replace it. All MAX II devices will have some fluctuation in power-up timing. Designers should ensure that systems relying on a MAX II device to perform power up functions are using the MAX II device in accordance with the specifications given in the Data Sheet.

Before performing a test to verify the power-up time of a MAX II device under a certain load, you should set the V_{CCINT} supply to 2.5 V or 3.3 V, depending on what it will be in the final system. The shunt on J9 controls this value. If the shunt is present on J9, the MAX II device's V_{CCINT} is 2.5 V; if the shunt is not present on J9, the V_{CCINT} value is 3.3 V.

The MAX II device data sheet specifies that a MAX II device will be functional less than 300 μ s after minimum V_{CC} level is reached. In actuality, configuration starts at a voltage below minimum V_{CC} . A MAX II device on a board where the V_{CC} rise time is greater than 1 ms will be fully powered-up and configured before the supply reaches minimum V_{CC} . The Power-up demo allows users to investigate the power-up time in two different ways. The first is a race against the MAX II device that helps define what "Instant-on" means. The second is a much more detailed investigation of the power-up time that requires an oscilloscope, but provides a thorough understanding of how a MAX II device powers up under different loads.

On Board Circuit

The circuit on the board consists of a power regulator that provides the V_{CCINT} voltage. The power regulator can be set to 2.5 V or 3.3 V by adding or removing a shunt on J9. (If the shunt is in place, $V_{CCINT} = 2.5$ V; if the shunt is not in place, $V_{CCINT} = 3.3$ V.) The load on the regulator can be increased by a variable resistor (POT1). Four test points are also provided on the board: V_{CCINT} , V_{CCIO} , GND, and a MAX II User I/O pin. These four test points are labeled Active I/O Test Points and are located near the prototyping area on the board. Refer to the *MAX II Development Board Data Sheet* if you cannot locate the test points on your board. These test points allow for oscilloscope probes to be attached so the outputs can be thoroughly examined.

Figure 2–3. Active I/O Circuit Diagram

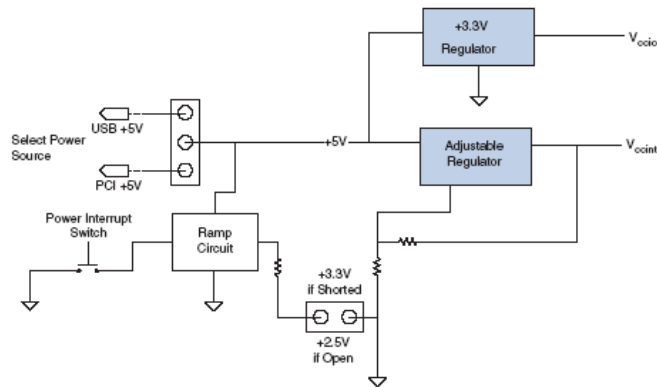

Using the Demo

Test 1: Race Against the MAX II Device

1. Program the MAX II device with the **InstantOn.pof** demo, located in the `<root>/Examples/HW/Demos` directory. (Refer to [“Programming the MAX II Device”](#) on page 2–4 for details on how to load POF files into the MAX II device.)
2. The following message scrolls across the LCD. Wait for the message to complete:

The MAX II device is instant= on. What is an instant? The MAX II device measures and displays T_{CONFIG} . It also shows how much shorter this instant is than the shortest time in which you can push S2.

3. The LCD displays the following:

```
TCONFIG = 137us
SW2 low = 000*TCfg
```

T_{CONFIG} refers to the time it takes the MAX II device to configure under the current loading conditions. $SW2_{low}$ refers to the number of times the MAX II device could have configured itself in the time that the button was depressed. This time is displayed as a multiple of the number of times that the MAX II device could have been

configured. Press S2 and the 000 changes to the number of times that the MAX II device could have configured itself in that interval (typical values should be between 300-600 for fast button pushers).

Test 2. Using a Scope to Measure Power-Up Times

1. Program the MAX II device with the **InstantOnDemo.pof** file that is located in the `<root>/Examples/HW/Demos` directory. (Refer to “Programming the MAX II Device” on page 2–4 for details on how to load POF files into the MAX II device.)
2. Attach scope probes to the four Active I/O test points located near the prototyping area on the board.
3. Set the trigger on the scope to the channel connected to the V_{CCINT} test point and trigger on the rising edge (LVTTTL logic level).
4. Set the load on V_{CCINT} to the desired amount by tuning the variable resistor (potentiometer), labeled POT1.
5. Press S5 on the board to interrupt the power and observe the ramp time of V_{CCINT} via the provided test point. A sample screen is shown below (see Figure 2–4).

Understanding the Results

The most detailed analysis of the power-up character of a MAX II device comes from viewing probe points during the power-up cycle with a digital oscilloscope. The development board has a variable core V_{CC} rise time control. This system uses POT1 to vary the MAX II core V_{CC} rise time from 80 μ s to 150 ms. The on-board test points provide users with an easy way to examine the ramp time of V_{CCINT} and the resulting configuration completion time. The ramp time of V_{CCINT} can be varied with POT1, thus allowing this circuit to match almost any system’s power-up rise time and analyze how the MAX II device performs. To make power cycling even easier, S5 will power cycle the MAX II V_{CCINT} supply any time it is pressed and released. The development board provides four useful probe points:

- $V_{INT} = V_{CCINT}$ (MAX II core voltage supply)
- $V_{IO} = V_{CCIO}$ (MAX II I/O voltage supply)
- GND = Board Ground plane
- ACTIVE_IO = MAX II User I/O pin P12

V_INT shows the Core V_{CC} rise time, and the rise time variation caused by POT1. ACTIVE_IO is driven by a MAX II user I/O pin that helps demonstrate the instant MAX II becomes functional (powered-up and configured).

Figure 2–4 shows a typical digital oscilloscope output. For this test the V_{CCINT} rise time is 10 ms. The device is functional at 2.18 V, well below the minimum V_{CC} level of 3.0 V. The I/O Pin starts out low, and at about a core V_{CC} of 1.25 V the I/O pull-up becomes active and the I/O goes to the V_{CCIO} level.



In the development board setup, the V_{CCIO} ring is on a different supply than V_{CCINT}. The V_{CCIO} ring is a constant 3.3 V and does not power cycle when S5 is pressed.

In Figure 2–4, the MAX II representative I/O (labeled Active I/O on the test point on the board), switches to 0 V when V_{CCINT} is at 2.18 V. It switches after configuration is complete and the core registers are reset, and released and the I/O are released. Once working, this I/O pin will begin to oscillate with a high and low period equal to T_{CONFIG}, the time needed to move the configuration data from the Configuration Flash Memory (CFM) to the configuration SRAM. The first falling edge on this I/O (shown in the lighter color in Figure 2–4) is when configuration is complete. Measuring back the T_{CONFIG} of the first low pulse width of this Active I/O will show at approximately what core voltage configuration started.

Figure 2–4. Digital Oscilloscope Image of V_{CCINT} and MAX I/O During Power-Up

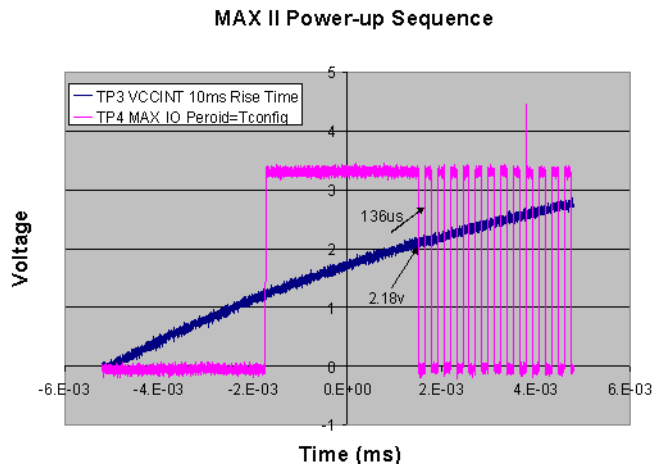

Low Power Demonstration

MAX II devices consume very little power, making them ideal for use in systems where power is at a premium. The MAX II development board is equipped with two current sense circuits that allow users to measure the power consumed by the MAX II device at different design densities and toggle rates.

This demonstration provides an easy way to increase the number of registers in the design and the rate at which they are toggling. This gives you some understanding of the power that a MAX II device requires. The demonstration measures the current drawn by V_{CCINT} as the number of toggling registers (and the rate at which they toggle) is increased or decreased.

To calculate the power drawn, multiply the number of toggling registers by the voltage supply of V_{CCINT} (if the shunt on J9 is in place, $V_{CCINT} = 2.5\text{ V}$; if the shunt is off, $V_{CCINT} = 3.3\text{ V}$). Note that the power can always be calculated by measuring the voltage across the current sense resistors and then using Ohm's Law to calculate the current. The V_{CCINT} current is measured across two parallel 0.33 ohm resistors (R109 and R113). You can measure the voltage across either one of these resistors and then divide that by 0.165 ohms (the two 0.33 ohm resistors are in parallel for a total resistance of 0.165). Use Ohm's Law to calculate the current and

then the power. Similarly, the current drawn by V_{CCIO} is measured across R95 and R99. Using the same technique as described for V_{CCINT} allows you to calculate the total power being consumed by the MAX II device.



This circuit uses resistors with a specified variance of 5%, which means that the power measurement is not precise. This circuit is provided to give users a general understanding of the MAX II device power consumption. Users who need a precise power measurement should remove the resistors and measure the current with a multimeter across one of the pads where R109 and R113 reside. Users concerned with power consumption should also consult the *Understanding & Evaluating Power in MAX II Devices* chapter of the *MAX II Device Handbook*.

On-Board Circuit

The MAX II device current draw is measured across two 0.33 ohm resistors via a current sense device. The output of this device is fed to an A/D converter that generates a digital (serial) output to the MAX II device. The value of this number provides an indication of the current that is consumed by the MAX II device, allowing you to determine how much power the MAX II device is consuming.



Refer to the *MAX II Development Board Data Sheet* and the MAX II development board schematics for more information about the on-board circuitry.

Using the Demo

To use this demo, first program the MAX II device with the **LowPowerDemo.pof** file in the *<install directory>/Examples/HW/Demos* directory. (Refer to [“Programming the MAX II Device”](#) on page 2–4 for details on how to load POF files into the MAX II device.) After programming finishes, the LCD will read:

```
Current Is 24 mA
000 FF's
```

The switches control the operation of this demo:

- Switch 1 = reset
- Switch 2 = increase the number of flip-flops that are toggling by 150
- Switch 3 = decrease the number of flip-flops that are toggling by 150
- Switch 4 = double the rate at which the flip-flops are toggling

Real-Time ISP Demonstration

MAX II devices provide a feature called real-time ISP. Real-time ISP allows a device's Configuration Flash Memory (CFM) to be loaded with a new design while another design continues to function in the SRAM (volatile) portion of the device. After a new POF file has been loaded into the MAX II device with real-time ISP enabled, cycling power causes the new design to become active in the MAX II device. Further power cycles simply reload the design residing in the CFM (you cannot switch back and forth between two different designs).

Using the Demo



Any two designs will allow for investigation of this feature, with one important caveat—the design residing in the MAX II device cannot read from the UFM while the CFM is being overwritten (while actually programming the device). The example below holds true whether the designs used are included in this kit or are custom user designs. Two of the designs included in this kit continually read from the UFM and thus appear to fail when the **Real-Time ISP** option is used and another design is loaded into the CFM. These two designs are the **Vending Machine Demo** and the **Functional Test**. In order to view the **Real-Time ISP Demo**, you should avoid having these designs running in the MAX II device while loading a second design into the CFM. However, either of them can be loaded in the CFM while another design is running.

1. Program the MAX II device with the **FunctionalTest.pof** file. (Refer to [“Programming the MAX II Device”](#) on page 2–4 for details on how to load POF files into the MAX II device.)
2. Observe the design functioning as explained in [“Running the Functional Test”](#) on page 2–6.
3. Open the **VendingMachineDemo.pof** file in the Quartus II software.
4. Choose **Options** (Tools menu) and then click **Programmer** in the list of options on the left.
5. Check the **Enable real-time ISP to allow background programming** check box. See [Figure 2–5](#).

Figure 2–5. Programmer Options Dialog Box

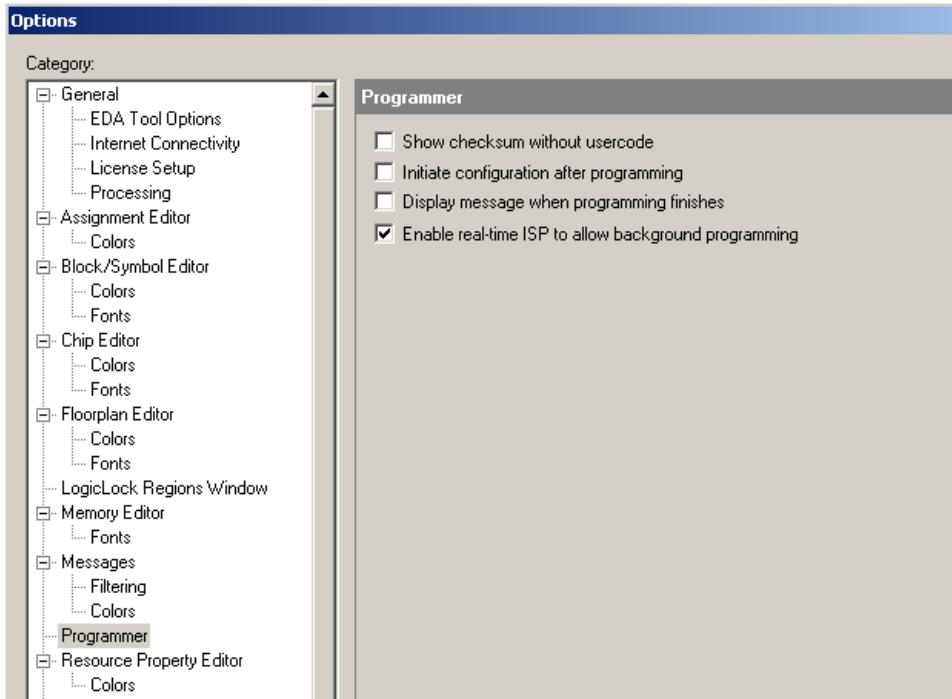

6. Program the MAX II device with the **VendingMachineDemo.pof** file.
7. Observe the Functional Test design still functioning as in step 2.
8. Press S5, which interrupts the V_{CCINT} (core voltage) power supply and forces the MAX II device to reconfigure.
9. Observe the Vending Machine Demo functioning as described below.



Pressing S5 again results in the MAX II device reconfiguring itself with the Vending Machine Demo. The Functional Test design is now gone and would have to be reloaded into the CFM via the Quartus II programmer in order to be loaded into the MAX II device again.

Vending Machine Functionality

After programming the board, you will see the first screen....“Ice Cold Drinks:”. The available drinks scroll along the bottom of the screen.

S1 resets the board to this first screen

S2 steps through the different screens in sequence:

Screen 1 : Scrolling Drinks

Screen 2 : Make Drink Selection...Press S3 to scroll through drinks

Screen 3 : Deposit funds.....Press S4 to add money

If not enough money has been added, the following message appears after pressing S2:

“Insufficient \$”

“Press S2”

This takes you back to screen 3. When the full amount has been deposited and S2 is pressed, you come to the final screen:

“Vending Drink”

“Thank You”

Press S1 or S2 to go back to screen 1. Note that the source code for the Vending Machine Demo is included. This is the only VHDL design that is included with the kit. It provides an example of the VHDL language for users new to programmable logic.

Reference Designs

The MAX II Development Kit provides three reference designs to show how the MAX II board (and the MAX II device) can interface with other systems.

Reference Design 1: USB Reference Design

The USB Reference Design provides an example of how to connect a PC to the MAX II development board using the on-board USB MAC from Future Technology Devices International (FTDI). The design consists of a Visual Basic Application and a Quartus II project. Source code for both projects is included on the *MAX II Development Kit CD-ROM*. The Verilog HDL code that makes up the MAX II design contains many explanatory comments. This design is appropriate for engineers new to programmable logic (particularly those with software experience) and provides an excellent starting point for understanding the way in which programmable logic devices (PLDs) manipulate data. This design was built such that both the software and hardware portions would be easy to understand, not for optimum speed or efficiency.

Using the USB Reference Design

1. Program the board with the **USBReferenceDesign.pof** file. (Refer to [“Programming the MAX II Device” on page 2–4](#) for details on how to load POF files into the MAX II device.)
2. To install the drivers, perform the following steps:

- a. When you plug the board into your PC, the message “Found New Hardware” appears. When that occurs, open your **Control Panel** and then open the System Menu. Click the **Hardware** tab and then click the **Device Manager**. In the **Device Manager** window look for an item called **Other Devices** between **Network Adapters** and **Ports (COM & LPT)**. If you see **Other Devices**, then you must install the drivers. Proceed to Step b.

If you don’t see **Other Devices**, then expand the **Ports (COM & LPT)** item and look for **USB Serial Port (COM X)**, where X is an integer. If you see the USB Serial Port, then the XP found the drivers and installed them. Proceed to Step 3.

- b. In the **Device Manager** window, expand the **Other Devices** item. Right click on **USB <- -> Serial** and click **Update Driver**. This will launch the **Found New Hardware Wizard**. In the Wizard menu select **Install from a list or specific location** and click **Next**.
 - c. Select **Don’t Search. I will choose the driver to install**. Click **Next**.
 - d. Leave **Show All Devices** highlighted and click **Next**.
 - e. Click **Have Disk**.
 - f. Click **Browse** and browse to the `<root>\Examples\HW\ReferenceDesigns\USB_ReferenceDesign\Win98_2k_XP_Drivers` directory. Click **Open**. This will return you to the **Install From Disk** menu. Click **OK** and then select **Next** in the Wizard menu. Driver installation should then complete. Click **Finish** and note that the **COM (Ports & LPT)** item in the **Device Manager** window now contains an item called **USB Serial Port (COM X)**, where X is an integer number. You will need to know the value of X, so make a note of it.
3. Start the **USB_Utility.exe** application located in the `<root>/Examples/HW/ReferenceDesigns/USB_ReferenceDesign/Software` directory. The user interface shown in [Figure 2–6](#) should appear.

Figure 2–6. USB Reference Design Dialog Box

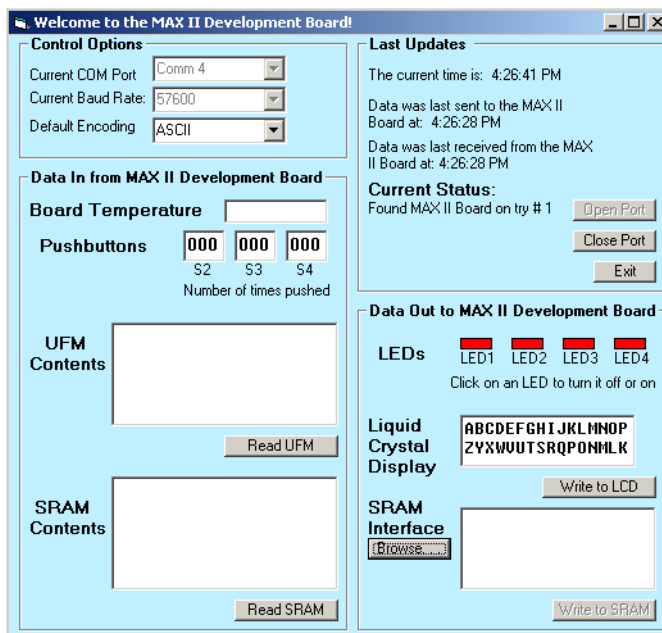

- On the Control Options menu select the appropriate COM port for your system. To find the correct COM port, **Browse** to the Windows Device Manager (**Control Panel > System > Hardware** tab > **Device Manager Button**). Expand the **Ports (COM & LPT)** item and you should see the **USB Serial Port (COM<number>)**. In [Figure 2–7](#) the board has been assigned COM4. This port number will be different on each machine.

After you find which COM port your machine has assigned the MAX II board, select that port in the **Current COM Port** drop down box in the MAX II USB Utility user interface (see [Figure 2–6](#)). Click **Open Port**. The application tries to communicate with the board. If successful communication is established, the status box on the application reports **Found MAX II Board on port X** (where X is the number of the port). If it was unsuccessful, the status box reports **Could not find MAX II Board**.

Figure 2-7. Device Manager Window

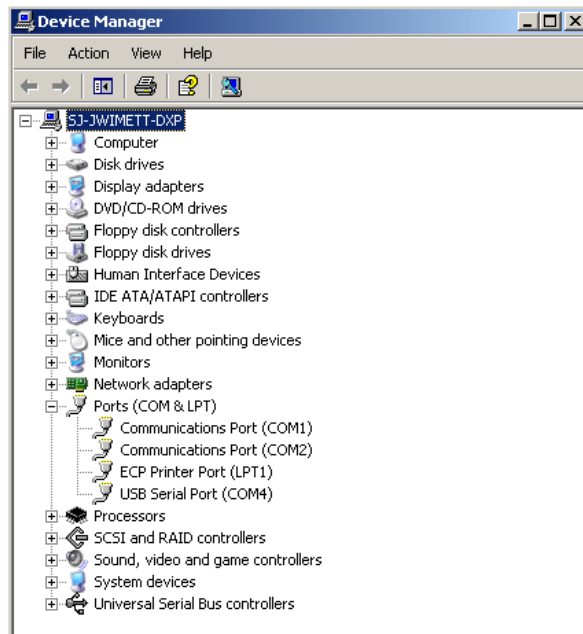

5. If successful communication is established, the LCD displays Connected to PC!.
6. The PC Application allows you to read from and write to most of the components on the MAX II board. Note the **Default Encoding** drop down box in the Control Options section of the user interface. This controls how the MAX II device interprets the data sent to and received from the MAX II board. If you select **Hexadecimal**, the PC will treat all data as hexadecimal characters. If you select **ASCII**, then the PC will interpret all data as ASCII.



This demo relies on the appropriate transmission of data from the PC to the board. If corrupt data is transmitted, errors will occur. The application on the PC may be unaware of hardware errors. The board will show hardware errors by flashing the LEDs. If you see that the LEDs are flashing, click the **Close Port** button on the PC application and press S1 on the development board. You can then re-open the port and use the demo as normal.

Note that LED8 remains lit. If this LED is off while the PC application is idle, an error has occurred. Close the port, reset the board by pressing S1, and re-open the port. If the PC application stops responding, disconnect the USB cable from the board. If that doesn't solve the problem, you will have to use the **Task Manager** in Windows to end the PC application manually.

7. Using the demo:

Perform the following tests on the USB Reference Design user interface (see [Figure 2-6](#)).

- a. *Check the LEDs*—Click on the LEDs and note that they turn on and off on the board as they do in the GUI.
- b. *Write to the LCD*—Type some text into the Liquid Crystal Display text box and click **Write to LCD**. The same text appears in the LCD display on the board.
- c. *Write to the SRAM*—First use Notepad to create a text file and **Save** the file on your hard drive. In the USB_Utility GUI, click the **Browse** button near the SRAM Interface. Browse to the file you just created. Make sure the default encoding list box says "ASCII" and click **Write to SRAM**.
- d. *Read from the SRAM*—First check that the Default Encoding list box says "ASCII" and then click **Read SRAM**. Make sure the SRAM contents text box shows the data that you typed into your Notepad file. Note that when you read from the SRAM, a file called **SRAMDataBack.txt** is created in the same directory where the **USB_Utility.exe** file resides. This file is re-created each time you read from the SRAM. It contains the addresses and the data read from those addresses.



SRAMDataBack.txt must not be open when you try to read from the SRAM.

- e. *Read the UFM*—The UFM is arranged as 256 locations, each containing 32 bits of data. Currently residing in the UFM is the inverse of each address. Set the default encoding to Hexadecimal and click **Read UFM**. The data displayed should be FFFF FFFE FFFD FFFC FFFB and so forth. You can recompile this design with a different memory initialization file (MIF) to change the data in the UFM. Note that when you read from the UFM, a file called **UFMDataBack.txt** is created in the same directory where the **USB_Utility.exe** file resides. This file is re-created each time you read the UFM. It contains the addresses and the data read from those addresses.



UFMDataBack.txt must not be open when you read from the UFM.

- f. *Display the board temperature and push button counts*—Press the S2, S3, and S4 buttons on the board. Note that each time a button is pressed, the corresponding text box on the GUI increments. Also note that the board temperature is updated each time a switch is pressed.



The SRAM and UFM read/write options only read or write 384 bytes at a time. This data is always written to or read from the 384 lowest address locations.

Understanding the Functionality of the USB Reference Design

The USB Reference Design has two pieces:

- Verilog code written to dictate the functionality of the MAX II device
- Visual Basic code to control the PC application

The MAX II design consists entirely of state machines. Each individual design file contains a state machine to control the reading/writing of each component. These files contain extensive comments and designers are encouraged to look through the Verilog code to gain a complete understanding of how the MAX II design functions. The **Director.v** code constantly awaits for one of two things to happen: either a button is pressed or data arrives from the PC. If a button is pressed, the Director enables the **PassivesInterface.v**, which takes over control of the output to the USB MAC FIFO and writes the values of the Switch Counters and Temperature blocks. If data is received from the PC, then the Director passes control to the **UFMInterface.v**, the **SRAMInterface.v**, or the **LCDInterface.v**, depending on the value of the data received. Refer to the Verilog code itself for more details on the operation of this MAX II design.

The Visual Basic project consists of the GUI and various pieces of code that control the transmission and reception of data and control characters to and from the MAX II board. All data is interpreted based on which command buttons are pressed. After a command button is pressed, it is disabled until the PC receives data for the corresponding component. When this data is received, the PC interprets it based on which command button is disabled and then processes it appropriately. After all data has been processed, the command button is enabled again.

The Visual Basic project relies heavily on drivers provided by Future Technology Devices International (FTDI), the company that manufactures the USB MAC. FTDI has several drivers available on their web site along with bits of Visual Basic code, C code, and documentation. Designers looking to interface to a PC in the same manner as this application are advised to investigate the driver solutions provided by FTDI. This application is formed around FTDI's Virtual COM Port drivers. These drivers essentially mimic a COM port on the PC, making the sending and receiving of data relatively easy.

The board is set up so that users can implement designs based on the other drivers provided by FTDI, but this does require a hardware modification—the footprint labeled J10 is for an EEPROM socket that can be added to the board and then populated with the designer's choice of EEPROMs. This EEPROM then allows designers to set the USB Product ID and Vendor ID, as well as allowing for USB 1.1 or USB 2.0 (High Speed) interfaces to be developed.

Reference Design 2: The Slot Game Reference Design

The MAX II Slot Game Reference Design highlights the high density of the MAX II device. The reference design uses approximately 1050 logic elements during implementation. This total logic cell usage is equivalent to roughly 800 macrocells in the legacy MAX architecture. Legacy MAX devices contained a maximum of 512 macrocells, making designs such as this impossible to implement without purchasing multiple devices.

Using the Slot Machine Reference Design

The MAX II Slot Game Reference Design is based on standard casino-style slot machine behavior. It uses a linear feedback shift register to determine the values of three simulated slot reels on the MAX II board's LCD. A player controls the progress of the game using three buttons on the MAX II board.

The object of the game is to build a total bankroll of \$1000 or more by using three levels of wagering. The game is initiated by hitting the **Bet** button (S2), at which time the player is given a default total of \$199. By

repeatedly pressing the **Bet** button, a player can select between three amounts they wish to wager on a particular turn of the simulated slot reels. When the player is satisfied with the wager amount, the **Spin** button (S4) is selected, initiating the simulated slot action. If all three slot reels display the same value, the player wins and his total is updated with the appropriate payoff. If the reels do not match, the wagered amount is subtracted from his earnings. Wager amounts and payoffs are listed in [Table 2-1](#). Play continues in this way until the player either reaches \$1000 or runs out of money. The player is allowed to select any of the wager amounts at any point in the game. A new game can be initiated at any time by recycling the board power plane (button S5).

Wager	Payoff
\$1	\$16
\$5	\$80
\$50	\$800

Understanding the Functionality of the Slot Machine Reference Design

A high level view of the reference design can be separated into the basic areas of functionality shown below.

Overview

The design functionality is based on a block of logic that monitors the status of two input signals. Based on the state of each of these inputs, the design sends the appropriate information to an LCD display through one of two paths. One path provides access to a block of on-chip flash memory that sends display instructions to the LCD. The other path stores values for a set of registers that keep track of the game status as it progresses. An LCD controller interprets the instructions provided by either path and supplies stimulus to the LCD hardware to render the appropriate images. See [Figure 2-8](#).

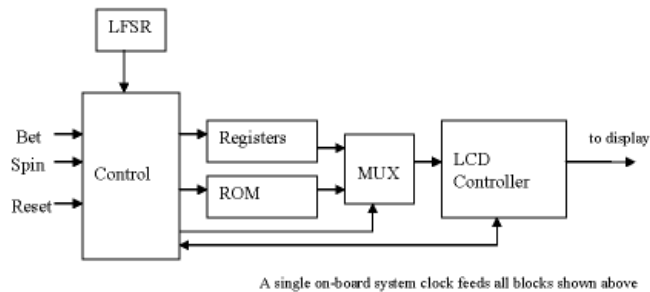
Figure 2–8. Design Overview

Linear Feedback Shift Register (LFSR)

The LFSR is a 32-bit register chain that uses combinational feedback paths to generate pseudo-random number values. Nine taps on the 32-bit chain are used to derive three decimal numbers that represent the value on each reel (3 taps per reel). The LFSR is fed by a system clock, and the values of each reel are constantly changing on the rising edge of each clock cycle. When a player toggles the **Spin** button during game play, the block captures the current value of each tap and feeds these values to the Control block for further processing. See [Figure 2–9](#).

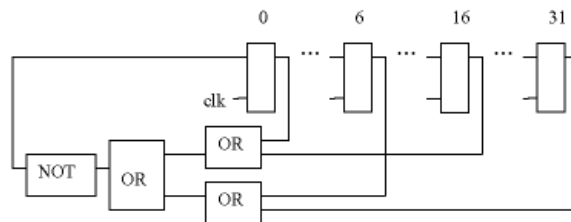
Figure 2–9. Linear Feedback Shift Register Design

Control

This block manages the status and functionality of the player controlled inputs **Bet** and **Spin**. The functionality of this block can be divided into three major areas:

- *Start-up*—When the MAX II device has been successfully programmed, the Control block automatically accesses a section of the UFM that prompts an introduction sequence to appear on the LCD screen. This sequence loops indefinitely until a player presses the **Bet** button to begin game play.
- *Bet Selection*—The **Bet** button provides access to three separate memory spaces within the UFM, representing the three fixed wager amounts. Each time the button is pressed, a memory pointer cycles to the next space in the sequence, displaying the corresponding wager amount on the LCD screen. The Control block keeps track of the memory pointer, and thus can cycle through the three wager values repeatedly.
- *Spin Engagement*—When the **Spin** button is toggled, the Control block state machine is sent through a series of actions that affect the final display of the LCD. First the LFSR is sampled and three pseudo-random values are generated from its output. Based on the commonality of these values, a new bankroll total is calculated and stored internally. This total is then divided into three separate values that represent the Hundreds, Tens, and Ones place of the number. These values, along with the LFSR generated values for each reel, are mapped to 11-bit codes that prompt the LCD to display the correct number value.

When the values have been calculated and mapped, the Registers block (see [Figure 2-8](#)) is updated with new bankroll and reel values. The block then uses the MUX function to access the flash memory block (for simulated spinning action of the reel), and the Register block (to display the final bankroll and reel values). Upon completion of this process, the design cycles back to monitor the status of the **Bet** signal to prepare for another spin.

LCD Controller

The MAX II Slot Game Reference Design communicates with the on-board LCD through a custom-built controller interface. The logic block performs several functions vital to the game behavior. Upon successful programming of the device, the block sequentially loads a series of specific codes that initialize the LCD hardware and configure the display environment. When initialization is complete, it interprets 11-bit instructions fed by the design's Control block, and manages the delivery of characters to be displayed on the screen. Based on the value of the 11-bit input bus, the controller handles changes to the speed, content, and direction (read/write) of LCD data.



For a detailed explanation of the controller functionality, see *White Paper: MAX II Development Board LCD Controller*.



The Slot Game Reference Design has added an extra bit to the **bus** input of the LCD controller. It is used to vary the speed of transactions to the LCD display. For more information on this bit and its functionality, refer to the `lcd_controller.v` file in the Slot Game Reference Design Quartus II Project.

Reset Functionality

At any point during game play, pressing the **Reset** button (S5) will cycle the board power, stop the game, and reload the design's programming file (`.pof`) into the SRAM (volatile) portion of the MAX II device via the Configuration Flash Memory. After the file has been reloaded, all registers are restored to their default value and the design returns to its initial introduction display.

Reference Design 3: PCI Reference Design

The PCI Reference Design provides an example of how users can interface the MAX II development board to a PC via the PCI expansion slots. The design uses Altera's PCI T32 MegaCore function to interface to the PCI Bus of any standard PC. All design files are provided in the `<root>/HW/Examples/ReferenceDesigns/PCI_Reference Design/QuartusProject/DesignFiles` directory.



The MAX II PCI demo shows a simple example of how to generate interrupts. When a user presses one of the switches, an interrupt is generated. In a PCI system, the interrupts are shared between many devices. Special care is required that the user does not press a switch unless the MAX II PCI application is active.

Using the Reference Design

1. Program the MAX II device with the `PCI_RefDesign.pof` file. (Refer to ["Programming the MAX II Device"](#) on page 2-4 for details on how to load POF files into the MAX II device.)
2. Register the drivers:
 - a. Open a command prompt (DOS window).
 - b. CD to the `<root>/Examples/HW/ReferenceDesigns/PCI_ReferenceDesign/Win2k_XP_Drivers` directory.

- c. Type the following commands:

```
wdreg.exe -inf <root>\Examples\HW\ReferenceDesigns\  
PCI_ReferenceDesign\Win2k_XP_Drivers\windrvr6.inf  
install ←
```

```
wdreg -inf <root>\Examples\HW\ReferenceDesigns\  
PCI_ReferenceDesign\Win2k_XP_Drivers\  
altera_maxiipci.inf install ←
```

3. Turn off your PC and install the MAX II development board in an available PCI slot. (Refer to your PC's hardware installation documentation.)
4. Power-up the PC.
5. Install the drivers:

If you are using the Windows 2000 operating system, the operating system detects the MAX II development board as new hardware and prompts you to install a driver. Perform the following steps in the **Found New Hardware Wizard**:

- a. Click **Next** to go to the **Install Hardware Device Drivers** page.
- b. Turn on the **Search for a suitable driver for my device (recommended)** option.
- c. Click **Next** to go to the **Locate Driver Files** page.
- d. Turn off all of the options under **Optional Search Locations**.
- e. Click **Next** to go to the **Driver Files Search Results** page.
- f. Click **Next** to go to the **Completing the Found New Hardware Wizard** page.
- g. Click **Finish** to complete the driver installation.

If your PC has the Windows XP operating system, the operating system detects the MAX II development board as new hardware and prompts you to install a driver.

Perform the following steps in the **Found New Hardware Wizard**:

- a. Turn on the **Install the software automatically (Recommended)** option.

- b. Click **Next** to go to the **Completing the Found New Hardware Wizard** window.
 - c. Click **Finish** to complete the driver installation.
 6. Launch the **maxiipci.exe** application located in the `<root>Examples/HW/ReferenceDesigns/PCI_ReferenceDesign/PC_Application` directory.
 7. To demonstrate reading from and writing to the SRAM, perform the following steps:
 - a. In the MAX II PCI application, choose the command to be **Target Loop** (default).
 - b. Set the Address Offset to 0x0 (default).
 - c. Change the number of bytes to 512.
 - d. Choose the data type to be **Random** (default).
 - e. Click **Execute**.
 - f. Review the results in the display window.
 8. To demonstrate control of the LEDs, do the following:
 - a. Click on any one of the check boxes above the LEDs.
 - b. Verify that the corresponding LED lights up on the board.
 9. To demonstrate reading the value from the temperature sensor, do the following:
 - a. Click on the **Read** button (under the temperature control group) of the application. The data read from the sensor is displayed in Centigrade.
 - b. Click the **F** radio button to convert the value to Fahrenheit.
 10. To demonstrate reading the PCI configuration registers, do the following:
 - ✓ Click on the **Read** button (under the Config register group) of the application. The value of the various configuration registers is displayed in the application.

11. Push one of the four user-defined push switches on the board to generate an interrupt. The application reads the corresponding register to figure out which switch was pushed and clears the interrupt. A dialog box appears when an interrupt is received (see [Figure 2–10](#)). If multiple switches are pushed at the same time, multiple dialog boxes appear.

Figure 2–10. Interrupt Received Dialog Box



