

1431-18 OR 1431-18BK3 - VIEW FROM TOP (SOLD SEPERATELY)

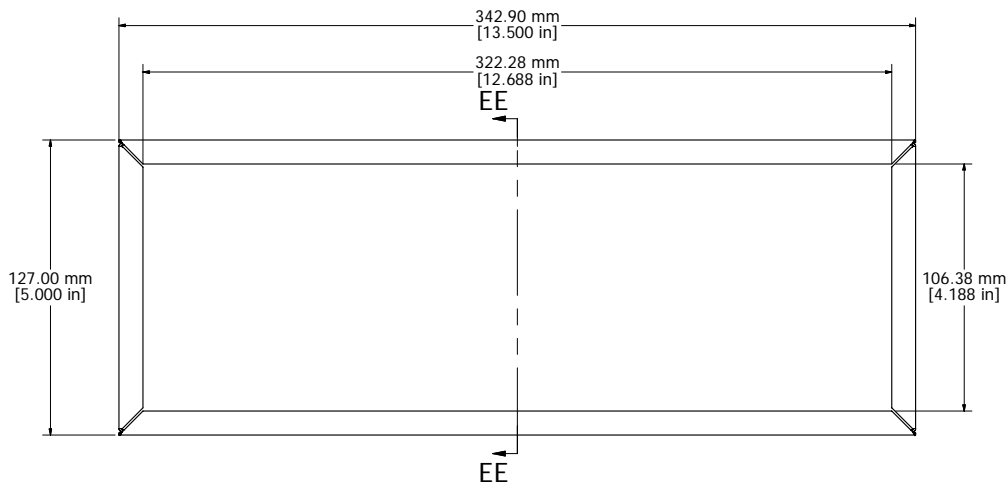

1441-18 OR 1441-18BK3 - VIEW FROM TOP (SOLD SEPERATELY)

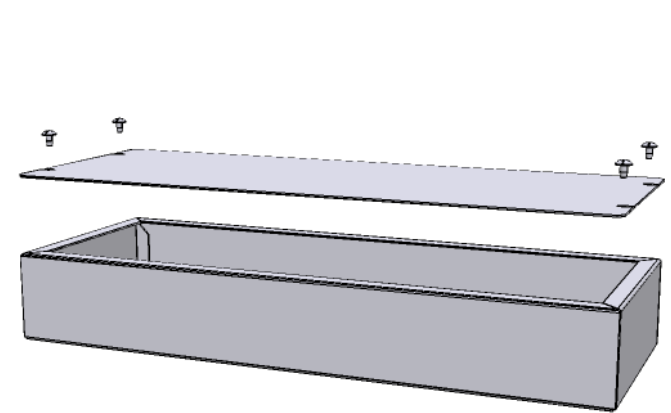
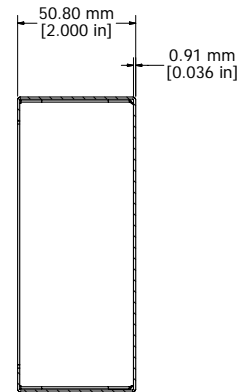

SECTION EE-EE

- CHASIS - 0.036" 20 GAUGE STEEL - ASA 61 GREY - 1441-18
- COVER - 0.036" 20 GAUGE STEEL - ASA 61 GREY - 1431-18
- CHASIS - 0.036" 20 GAUGE STEEL - BLACK - 1441-18BK3
- COVER - 0.036" 20 GAUGE STEEL - BLACK - 1431-18BK3
- SCREWS (6-32 x 1/4 SHEET METAL SCREWS) (SOLD SEPERATELY) - 1421J6

Contact Factory mjm@hammondmfg.com for quotes
 Enclosures can be Factory Modified (Milling, Drilling, Printing etc.)
 Solid models of this enclosure available in STEP or IGES.



**HAMMOND
 MANUFACTURING™**

1441-18

www.hammondmfg.com