

PART NUMBER	SML-LXR851GC-TR	REV.	D
DATE	E.C.N. NUMBER AND REVISION COMMENTS		REV.
07.18.00	E.C.N. #10644.		A
09.07.04	E.C.N. #10967.		B
12.13.07	E.C.N. #11148.		C
05.16.11	E.C.N. #11710/10BRDR. & REDRAWN.		D

ELECTRO-OPTICAL CHARACTERISTICS TA =25°C If=20mA

PARAMETER	MIN	TYP.	MAX	UNITS	TEST COND
PEAK WAVELENGTH		565		nm	
FORWARD VOLTAGE		2.2	2.6	Vf	
REVERSE VOLTAGE	5.0			Vr	If=100µA
AXIAL INTENSITY		11		mcd	If=20mA
VIEWING ANGLE		160		2x theta	
EMITTED COLOR:	GREEN				
EPOXY LENS FINISH:	WATER CLEAR				

LIMITS OF SAFE OPERATION AT 25°C

PARAMETER	MAX	UNITS
PEAK FORWARD CURRENT*	160	mA
STEADY CURRENT	25	mA
POWER DISSIPATION	100	mW
DERATE FROM 25°C	-1.2	mW/°C
OPERATING TEMP.	-40 TO +85	°C
STORAGE TEMP.	-30 TO +90	°C

* t<10µs

**CAUTION: MOISTURE SENSITIVE DEVICE
PER JEDEC LEVEL 2 STANDARDS**

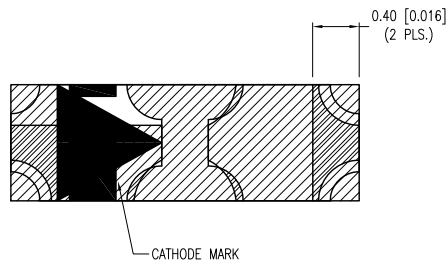
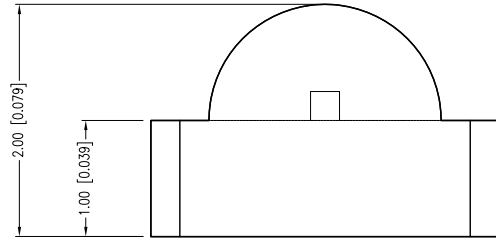
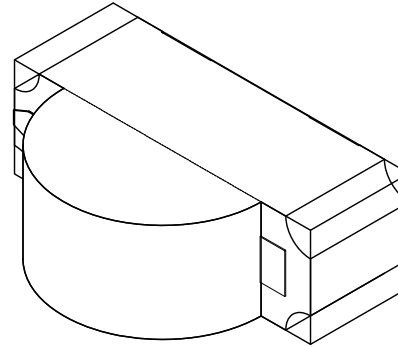
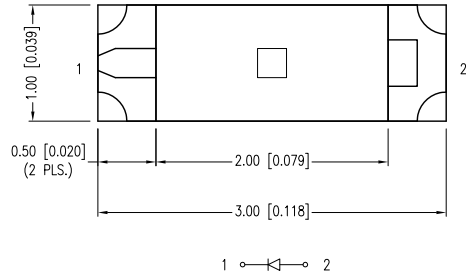

RECOMMENDED SOLDER PAD LAYOUT

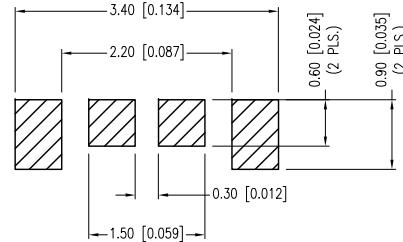

*UNLESS OTHERWISE SPECIFIED TOLERANCES PER DECIMAL PRECISION ARE: X=±1 (±0.039), X.X=±0.5 (±0.020), X.XX=±0.25 (±0.010), X.XXX=±0.127 (±0.005). LEAD SIZE=±0.05 (±0.002), LEAD LENGTH=±0.75 (±0.030). MIN.= +DECIMAL PRECISION MAX.= +0.00 -DECIMAL PRECISION



425 N. GARY AVE.
CAROL STREAM, IL 60188-4900
PHONE: +1.800.278.5666
FAX: +1.630.315.2152
WEB: WWW.LUMEX.COM
MEMBER OF ITW PHOTONICS GROUP

1.0x3.0mm PCB RIGHT ANGLE SURFACE MOUNT LED, 565nm GREEN, WATER CLEAR LENS, TAPE & REEL.

THE SPECIFICATIONS MAY CHANGE AT ANY TIME WITHOUT NOTICE DUE TO NEW MATERIALS OR PRODUCT IMPROVEMENT.

CONFIDENTIAL INFORMATION
THE INFORMATION CONTAINED IN THIS DOCUMENT IS THE PROPERTY OF LUMEX INC. EXCEPT AS SPECIFICALLY AUTHORIZED IN WRITING BY LUMEX INC., THE HOLDER OF THIS DOCUMENT SHALL KEEP ALL INFORMATION CONTAINED HEREIN CONFIDENTIAL AND SHALL PROTECT SAME IN WHOLE OR IN PART FROM DISCLOSURE AND DISSEMINATION TO ALL THIRD PARTIES.

DATE:	05.16.11	DRAWN BY:	AB
PAGE:	1 OF 2	CHKD BY:	KF
SCALE:	NTS	APRVD BY:	SS
UNIT:	mm [INCH]		

PART NUMBER	SML-LXR851GC-TR	REV.	D
DATE	E.C.N. NUMBER AND REVISION COMMENTS		REV.
07.18.00	E.C.N. #10644.		A
09.07.04	E.C.N. #10967.		B
12.13.07	E.C.N. #11148.		C
05.16.11	E.C.N. #11710/10BRDR. & REDRAWN.		D

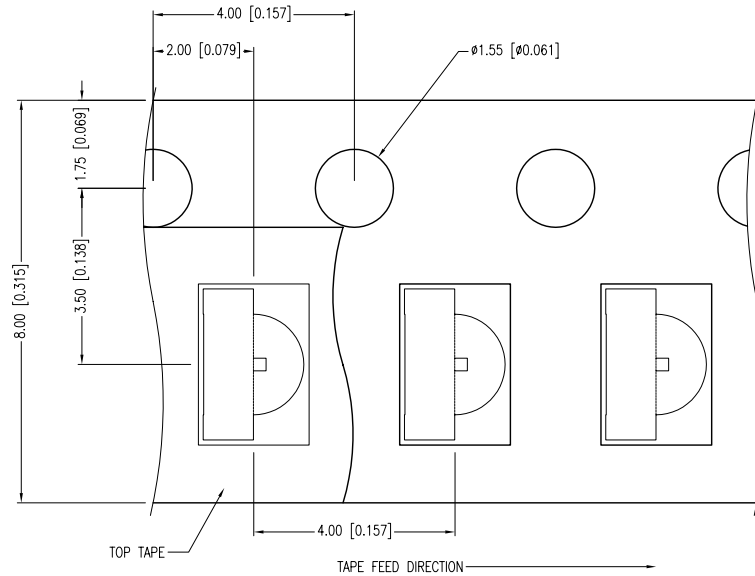
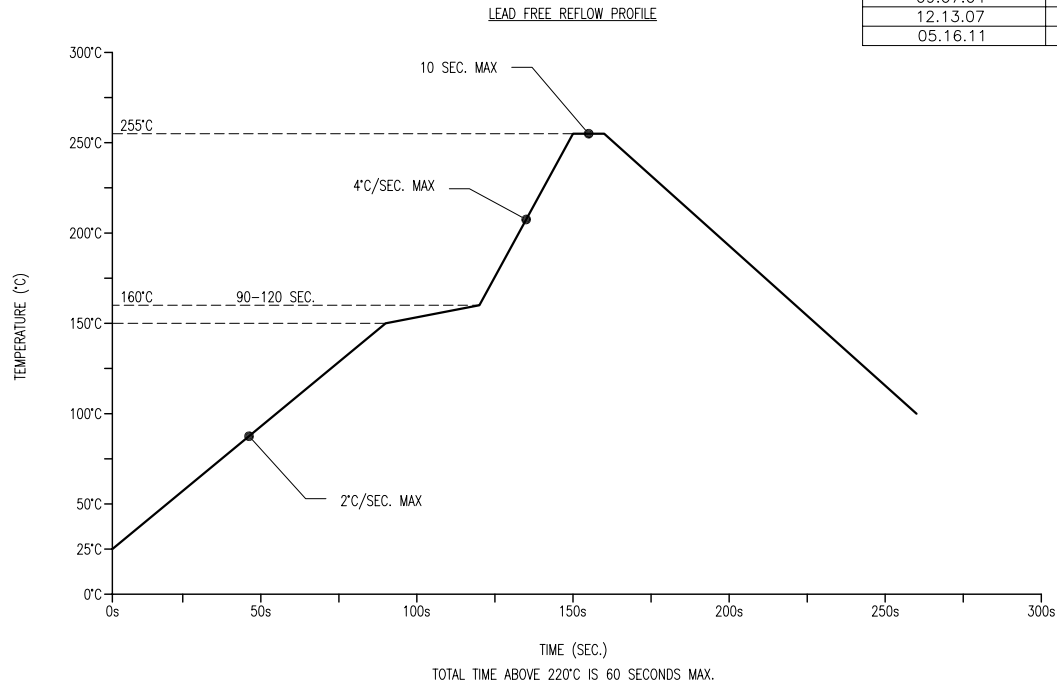

- NOTES:**
- 2,000 PER REEL.
 - THE CATHODE IS ORIENTED TOWARDS THE TAPE SPROCKET HOLE.

*UNLESS OTHERWISE SPECIFIED TOLERANCES PER DECIMAL PRECISION ARE: X=±1 (±0.039), X.X=±0.5 (±0.020), X.XX=±0.25 (±0.010), X.XXX=±0.127 (±0.005). LEAD SIZE=±0.05 (±0.002), LEAD LENGTH=±0.75 (±0.030). MIN= ^{+0.00} DECIMAL PRECISION _{-0.00} MAX.= ^{+0.00} DECIMAL PRECISION _{-0.00}



290 E. HELEN ROAD
 PALATINE, IL 60067-6976
 PHONE: +1.847.359.2790
 FAX: +1.847.359.6538
 WEB: WWW.LUMEX.COM

1.0x3.0mm PCB RIGHT ANGLE SURFACE MOUNT LED, 565nm GREEN, WATER CLEAR LENS, TAPE & REEL.

THE SPECIFICATIONS MAY CHANGE AT ANY TIME WITHOUT NOTICE DUE TO NEW MATERIALS OR PRODUCT IMPROVEMENT.

CONFIDENTIAL INFORMATION
 THE INFORMATION CONTAINED IN THIS DOCUMENT IS THE PROPERTY OF LUMEX INC. EXCEPT AS SPECIFICALLY AUTHORIZED IN WRITING BY LUMEX INC., THE HOLDER OF THIS DOCUMENT SHALL KEEP ALL INFORMATION CONTAINED HEREIN CONFIDENTIAL AND SHALL PROTECT SAME IN WHOLE OR IN PART FROM DISCLOSURE AND DISSEMINATION TO ALL THIRD PARTIES.

DATE:	05.16.11	DRAWN BY:	AB
PAGE:	2 OF 2	CHKD BY:	KF
SCALE:	NTS	APRVD BY:	SS
UNIT:	mm [INCH]		Ⓟ