

4A, 23V, 500kHz, ACOT™ Synchronous Buck Converter

Purpose

The RT6219A is an ACOT™ synchronous Buck converter with the input voltage range from 5V to 23V and provides 4A output current. This document explains the function and use of the RT6219A evaluation board (EVB), and provides information to enable operation, modification of the evaluation board and circuit to suit individual requirements.

Table of Contents

Purpose.....	1
Introduction.....	2
Key Performance Summary Table.....	2
Bench Test Setup Conditions.....	3
Schematic, Bill of Materials & Board Layout.....	5
More Information.....	8
Important Notice for Richtek Evaluation Board.....	8

Introduction

General Product Information

The RT6219A is a synchronous Buck converter with Advanced Constant On-Time (ACOT™) mode control which provides a very fast transient response with no external compensators. The RT6219A operates from 5V to 23V input voltage, provides complete protection functions including Over Current Protection (OCP), Under Voltage Protection (UVP) and Over Voltage Protection (OVP). This IC also provides a 1.5ms internal soft-start function and an open-drain power good indicator.

Product Feature

- 5V to 23V Input Voltage Range
- Adjustable from 0.6V to 5V Output Range
- Up to 98% Duty for 2S Battery Application
- 500kHz Switching Frequency
- Fixed Switching Frequency: 500kHz
- ACOT™ Mode Performs Fast Transient Response
- Integrated MOSFETs
 - ▶ 67mΩ of High-Side MOSFET
 - ▶ 41mΩ of Low-Side MOSFET
- Supports MLCC Output Capacitors
- Internal Soft-Start (1.5ms typ)
- Built-in OVP/UVP/OCP
- Power Good Indicator
- Thermal Shutdown

Key Performance Summary Table

Key Features	Evaluation Board Number : PCB049_V1
Input Voltage Range	5V to 23V
Max Output Current	4A
Default Output Voltage	5V
Default Marking & Package Type	RT6219AGQW, WDFN-10L 3x3
Operation Frequency	500kHz at CCM

Bench Test Setup Conditions

Headers Description and Placement

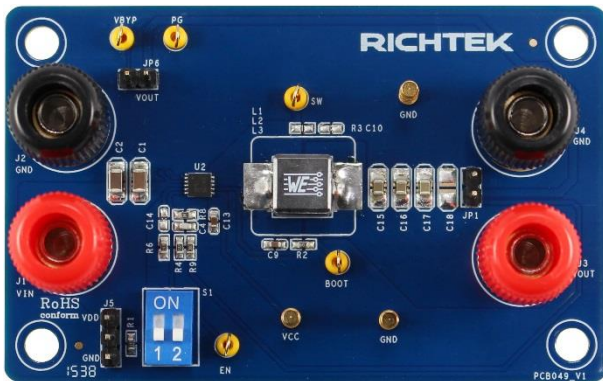

Top View

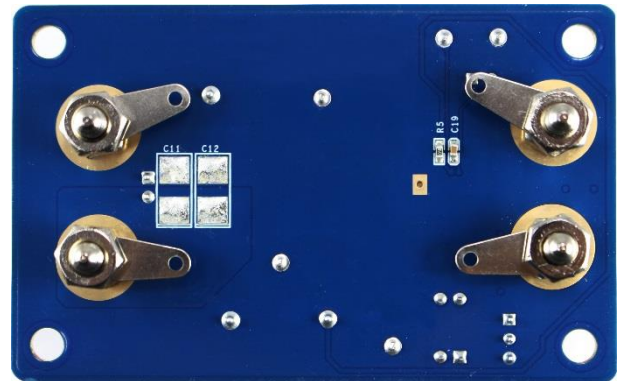

Bottom View

Please carefully inspect the EVB IC and external components, comparing them to the following Bill of Materials, to ensure that all components are installed and undamaged. If any components are missing or damaged during transportation, please contact the distributor or send e-mail to evb_service@richtek.com

Test Points

The EVB is provided with the test points and pin names listed in the table below.

Test point/ Pin name	Signal	Comment (expected waveforms or voltage levels on test points)
EN	Enable test point	Enable Control Input. Do not leave this pin floating. The slew rate of EN is recommended to be slower than 4.8V/ μ s.
GND	Ground	Ground.
PG	Power good indicator	Open-Drain Power Good Indicator Output.
VBYP	External 5V supply	Switch Over Input Supply Voltage for VCC. A low pass filter should be connected to GND, if VBYP is applied. If VBYP is not used, then connect to GND.
VCC	Internal regulator output	5V Linear Regulator Output for Internal Control Circuit. Bypass VCC to AGND with a 2.2 μ F capacitor. VCC can only supply internal circuits. Do not connect to external loads.
BOOT	Bootstrap supply test point	Bootstrap Supply for High-Side Gate Driver. A capacitor is needed to drive the power switch's gate above the supply voltage. It is connected between the SW and BOOT pins to form a floating supply across the power switch driver.
SW	Switch node test point	Switch Node.

Power-up & Measurement Procedure

1. Connect input power ($5V < V_{IN} < 23V$) and input ground to VIN and GND test pins respectively.
2. Connect positive end and negative terminals of load to VOUT and GND test pins respectively.
3. There is a 3-pin header “J5” for enable control. To use a jumper at “VDD” option to tie EN test pin to input power VIN for enabling the device. Inversely, to use a jumper at “GND” option to tie EN test pin and ground GND for disabling the device.
4. Verify the output voltage (approximately 5V) between VOUT and GND.
5. Connect an external load up to 4A to the VOUT and GND terminals and verify the output voltage and current.

Output Voltage Setting

Set the output voltage with the resistive divider (R8, R4) between VOUT and GND with the midpoint connected to FB. The output is set by the following formula :

$$V_{OUT} = V_{FB} \times \left(1 + \frac{R4}{R8}\right)$$

Schematic, Bill of Materials & Board Layout

EVB Schematic Diagram

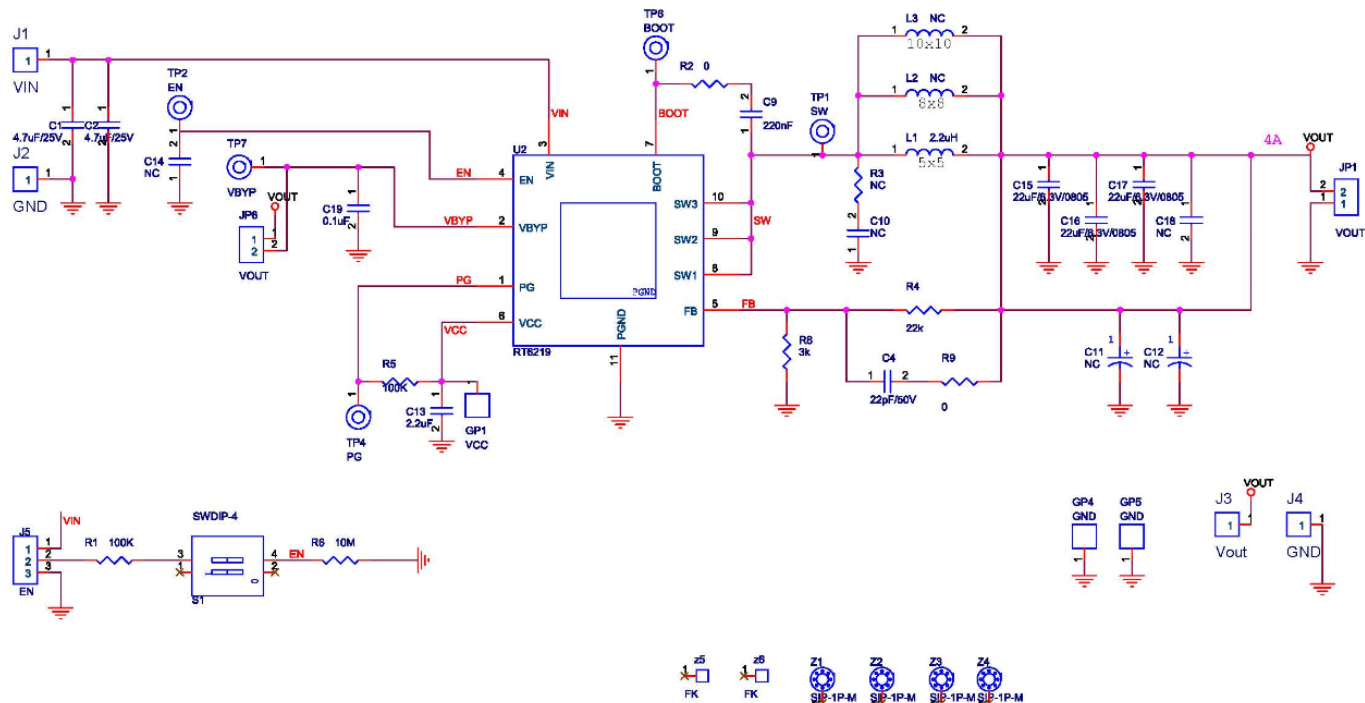

Bill of Materials

Reference	Qty	Part Number	Description	Package	Manufacture
U2	1	RT6219AGQW	DC/DC Converter	WDFN-10L 3x3	RICHTEK
C1, C2	2		4.7 μ F/25V	C-1206	
C4	1		22pF/50V	C-0603	
C9	1		220nF/50V	C-0603	
C10, C11, C12, C14, C18, R3	6	NC	NC	NC	NC
C13	1		2.2 μ F/50V	C-0603	
C15, C16, C17	3		22 μ F/6.3V/0805	C-0805	
C19	1		0.1 μ F/50V	C-0603	
L1	1		2.2 μ H		
R1, R5	2		100K	R-0603	
R2, R9	2		0	R-0603	
R4	1		22k	R-0603	
R6	1		10M	R-0603	
R8	1		3k	R-0603	

PCB Layout

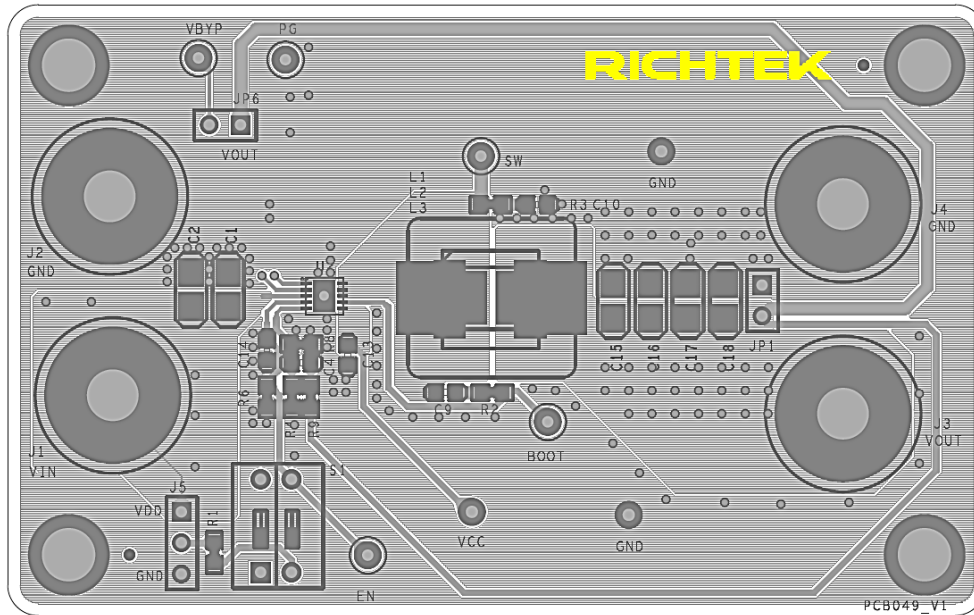

Top View (1st layer)

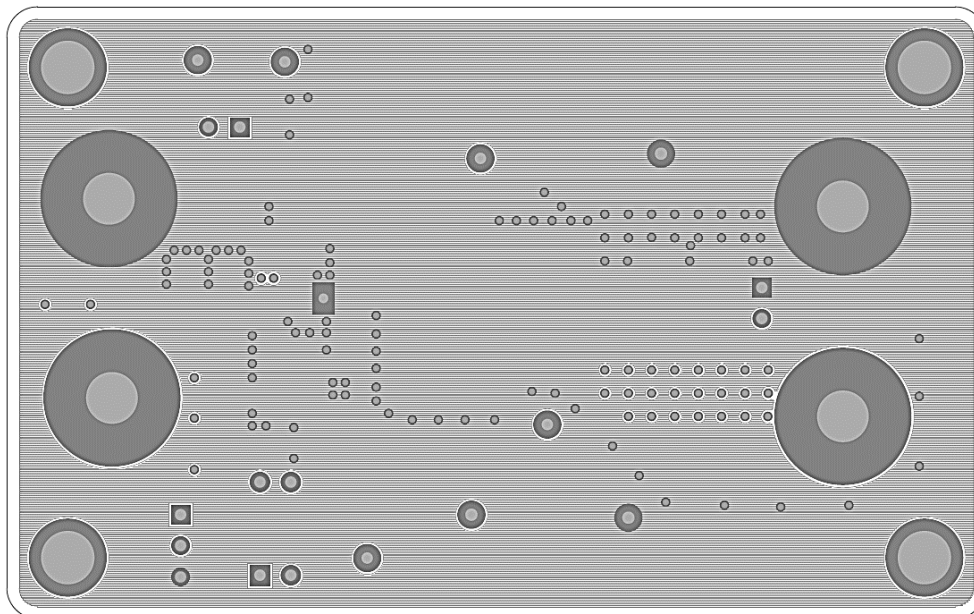

PCB Layout—Inner Side (2nd Layer)

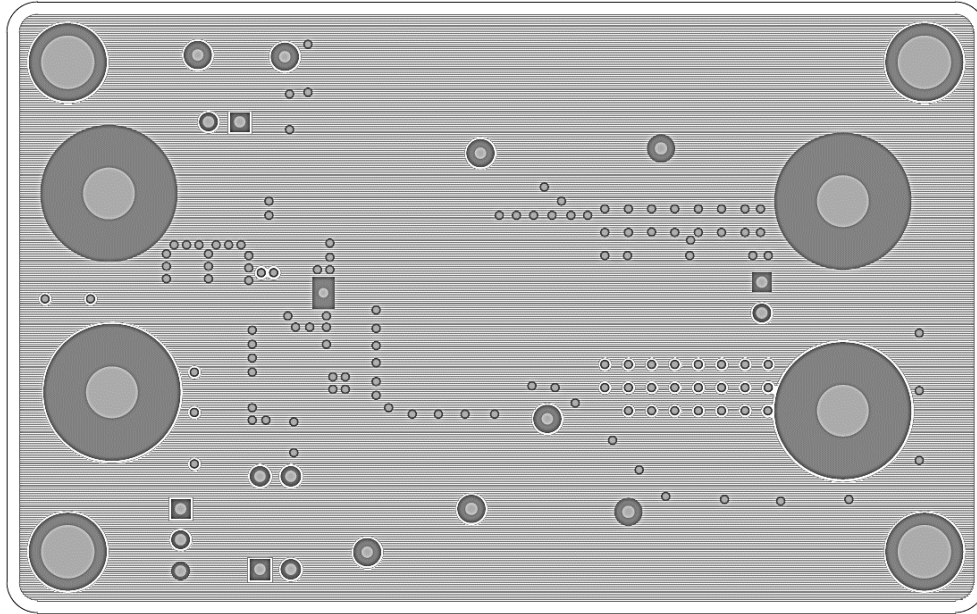

PCB Layout—Inner Side (3rd Layer)

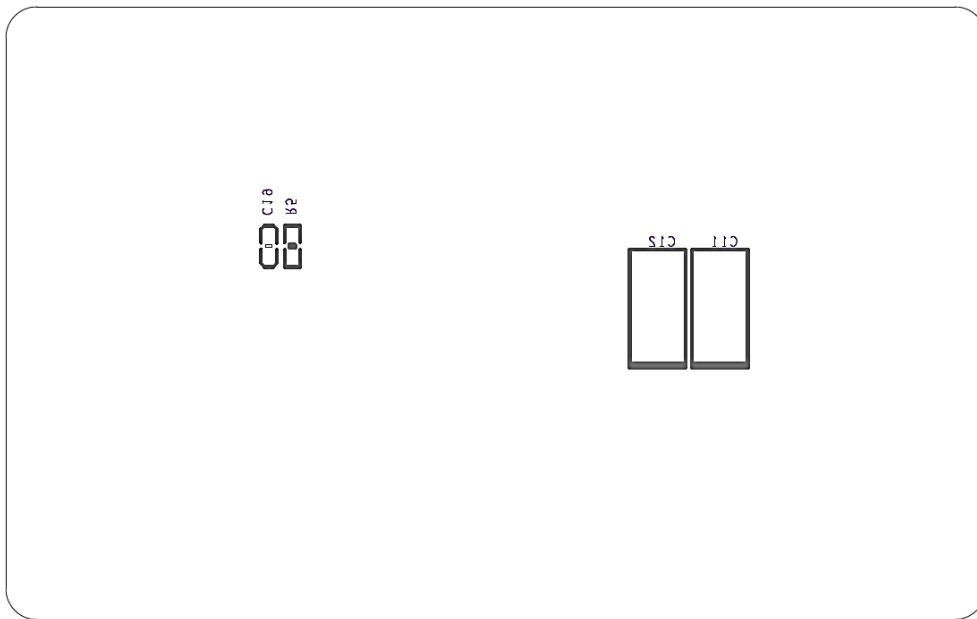

Bottom View

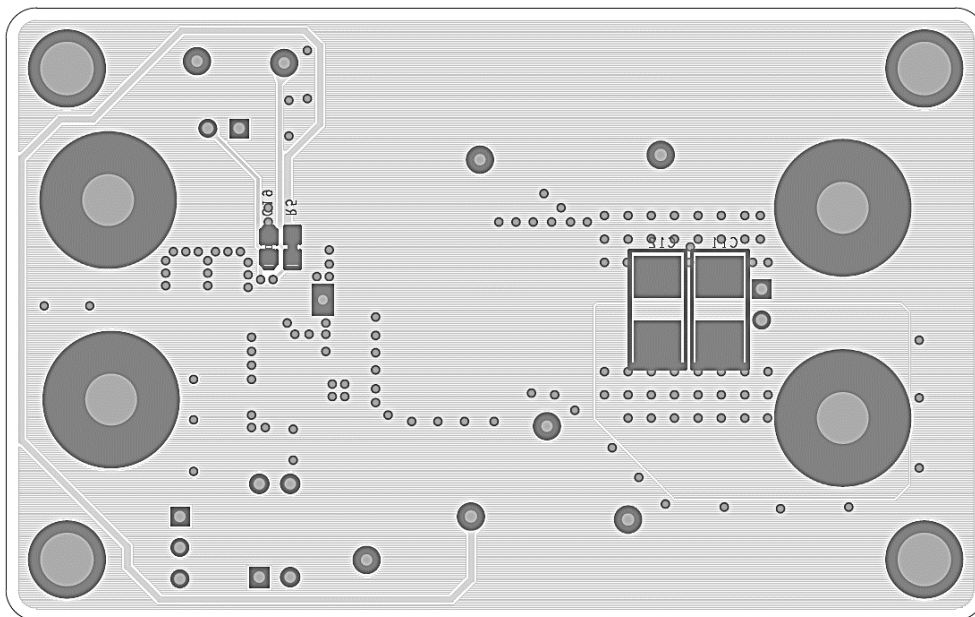

Bottom View (4th Layer)

More Information

For more information, please find the related datasheet or application notes from Richtek website <http://www.richtek.com>.

Important Notice for Richtek Evaluation Board

THIS DOCUMENT IS FOR REFERENCE ONLY, NOTHING CONTAINED IN THIS DOCUMENT SHALL BE CONSTRUED AS RICHTEK'S WARRANTY, EXPRESS OR IMPLIED, UNDER CONTRACT, TORT OR STATUTORY, WITH RESPECT TO THE PRESENTATION HEREIN. IN NO EVENT SHALL RICHTEK BE LIABLE TO BUYER OR USER FOR ANY AND ALL DAMAGES INCLUDING WITHOUT LIMITATION TO DIRECT, INDIRECT, SPECIAL, PUNITIVE OR CONSEQUENTIAL DAMAGES.