

1200 V 25 A Snubberless™ Triac

Datasheet – production data

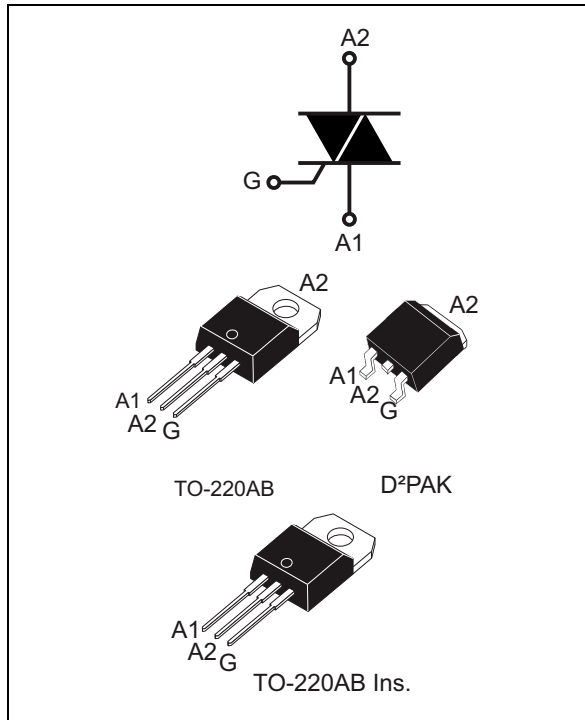

Description

Its 1200 V blocking voltage enables use in 3-phase industrial application. Its noise immunity and dynamic commutation makes it suitable for either inductive, capacitive or resistive load control. The T2550-12x is available in three packages: D²PAK, TO-220AB and TO-220AB insulated.

Table 1. Device summary

Order code	Package	V _{DRM} /V _{RRM}	I _{GT}
T2550-12G	D ² PAK	1200 V	50 mA
T2550-12T	TO-220AB	1200 V	50 mA
T2550-12I	TO-220AB Ins.	1200 V	50 mA

Features

- On-state current: 25 A
- Blocking voltage: 1200 V
- High static and dynamic commutation
- I_{GT} = 50 mA

Applications

- Industrial motor control circuits
- Industrial heating control circuits

Benefits

- High endurance reliability
- Compact high voltage device

TM: Snubberless is a trademark of STMicroelectronics

1 Characteristics

Table 2. Absolute ratings (limiting values, $T_j = 25\text{ °C}$ unless otherwise stated)

Symbol	Parameter		Value	Unit	
$I_{T(RMS)}$	On-state RMS current (180° conduction angle)	D ² PAK, TO-220AB	$T_c = 100\text{ °C}$	25	A
		TO-220AB Ins.	$T_c = 71\text{ °C}$		
I_{TSM}	Non repetitive surge peak on-state current (T_j initial = 25 °C)		$t_p = 16.7\text{ ms}$	252	A
			$t_p = 20\text{ ms}$	240	
I^2t	I ² t value for fusing		$t_p = 10\text{ ms}$	380	A ² s
V_{RRM} , V_{DRM}	Repetitive peak off-state voltage		$T_j = 125\text{ °C}$	1200	V
di/dt	Critical rate of rise of on-state current $I_G = 2 \times I_{GT}$, $t_r \leq 100\text{ ns}$	F = 60 Hz	$T_j = 125\text{ °C}$	100	A/ μ s
I_{GM}	Peak gate current		$t_p = 20\text{ }\mu$ s	4	A
V_{GM}	Peak positive gate voltage		$t_p = 20\text{ }\mu$ s	16	V
$P_{G(AV)}$	Average gate power dissipation			1	W
T_{stg}	Storage junction temperature range			- 40 to + 150	°C
T_j	Operating junction temperature range			- 40 to + 125	°C
V_{ins}	Insulation RMS voltage, 1 minute	TO-220AB Ins.		2500	V

Table 3. Electrical characteristics ($T_j = 25\text{ °C}$, unless otherwise specified)

Symbol	Test conditions	Quadrant	T_j		Value	Unit
$I_{GT}^{(1)}$	$V_D = 12\text{ V}$, $R_L = 33\text{ }\Omega$	I - II - III	25 °C	Min.	2.5	mA
				Max.	50	
V_{GT}	$V_D = 12\text{ V}$, $R_L = 33\text{ }\Omega$	I - II - III	25 °C	Max.	1.3	V
V_{GD}	$V_D = V_{DRM}$, $R_L = 3.3\text{ k}\Omega$	I - II - III	125 °C	Min.	0.2	V
$I_H^{(2)}$	$I_T = 500\text{ mA}$, gate open		25 °C	Max.	60	mA
I_L	$I_G = 1.2 I_{GT}$	I - II - III	25 °C	Max.	80	mA
dV/dt	$V_D = 67\% V_{DRM}/V_{RRM}$, gate open		125 °C	Min.	2500	V/ μ s
(di/dt) _c	Without snubber		125 °C	Min.	20	A/ms
t_{gt}	$I_{TM} = 13\text{ A}$, $V_D = 400\text{ V}$, $I_G = 100\text{ mA}$, $di_G/dt = 100\text{ mA}/\mu$ s, $R_L = 30\text{ }\Omega$	I - II - III	25 °C	Typ	2	μ s

1. Minimum I_{GT} is guaranteed at 5% of I_{GT} max.
2. For both polarities of A2 referenced to A1

Table 4. Static characteristics

Symbol	Test conditions		Value	Unit	
$V_T^{(1)}$	$I_{TM} = 35 \text{ A}$, $t_p = 380 \mu\text{s}$	$T_j = 25 \text{ }^\circ\text{C}$	Max.	1.55	V
$V_{t0}^{(1)}$	Threshold voltage	$T_j = 125 \text{ }^\circ\text{C}$	Max.	0.85	V
$R_d^{(1)}$	Dynamic resistance	$T_j = 125 \text{ }^\circ\text{C}$	Max.	20	m Ω
I_{DRM} I_{RRM}	$V_{DRM} = V_{RRM} = 1200 \text{ V}$	$T_j = 25 \text{ }^\circ\text{C}$	Max.	10	μA
		$T_j = 125 \text{ }^\circ\text{C}$		6	mA

1. For both polarities of A2 referenced to A1

Table 5. Thermal resistance

Symbol	Parameter		Value	Unit
$R_{th(j-c)}$	Junction to case (AC)	D ² PAK, TO-220AB	0.8	$^\circ\text{C/W}$
		TO-220AB Ins.	1.7	
$R_{th(j-a)}$	Junction to ambient	TO-220AB, TO-220AB Ins.	60	$^\circ\text{C/W}$
		S = 1 cm ² D ² PAK	45	

Figure 1. Maximum power dissipation versus on-state RMS current (full cycle)

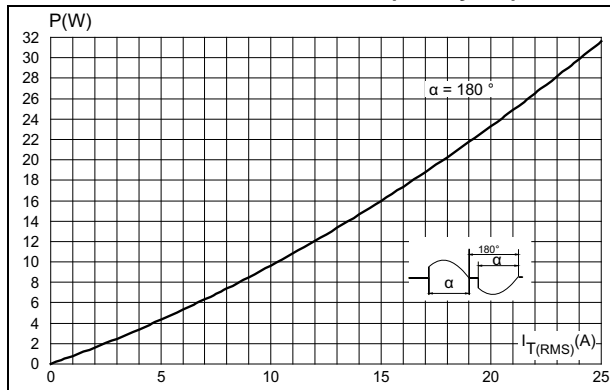

Figure 2. On-state RMS current versus case temperature

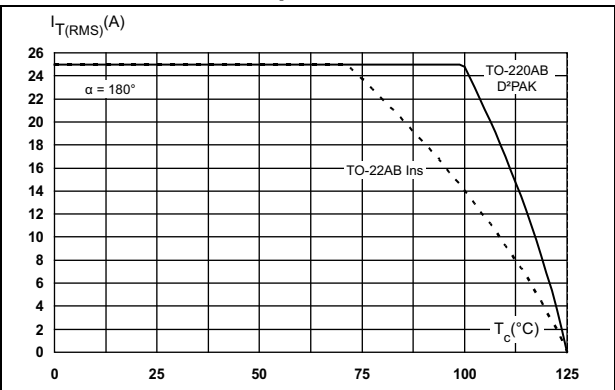

Figure 3. On-state RMS current versus ambient temperature (free air convection)

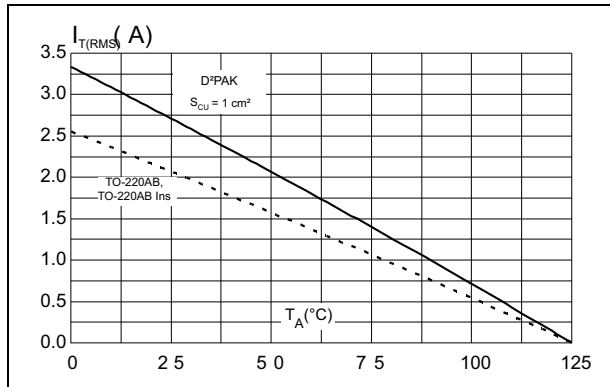

Figure 4. Surge peak on-state current versus number of cycles

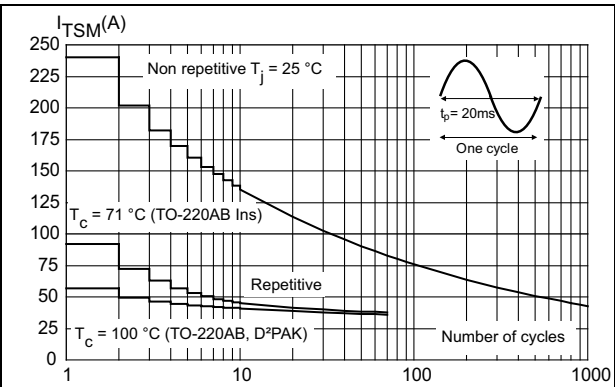

Figure 5. Relative variation of thermal impedance versus pulse duration (T2550-12I)

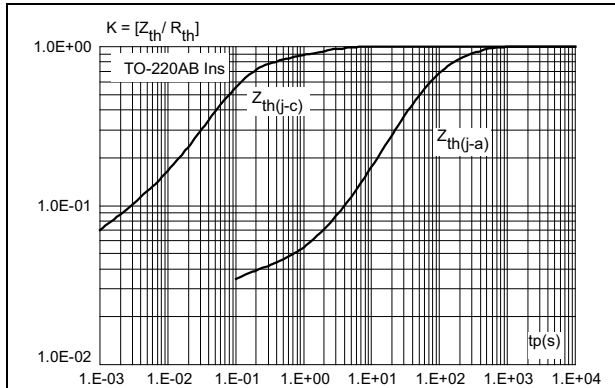

Figure 6. Relative variation of thermal impedance versus pulse duration

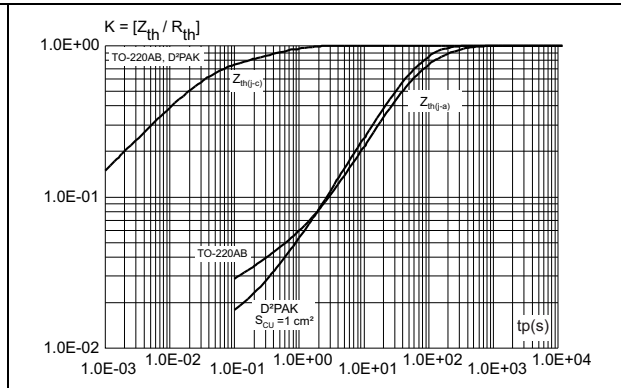

Figure 7. Relative variation of gate trigger current and gate voltage versus junction temperature (typical values)

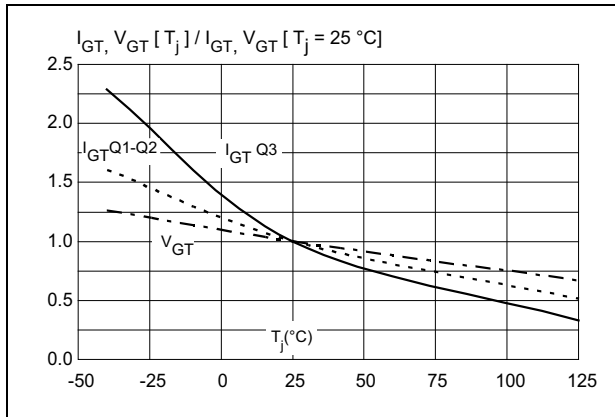

Figure 8. Relative variation of holding current and latching current versus junction temperature (typical values)

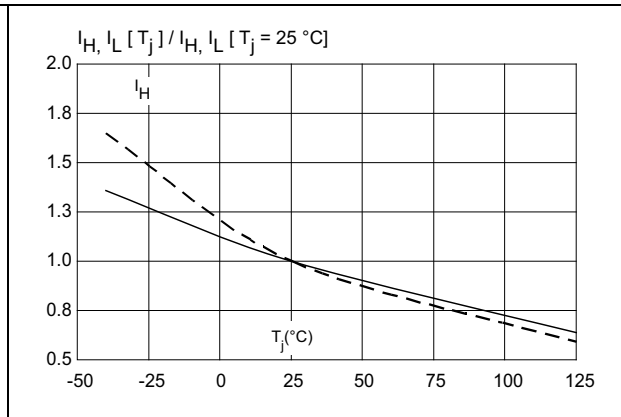

Figure 9. Relative variation of critical rate of decrease of main current versus junction temperature (typical values)

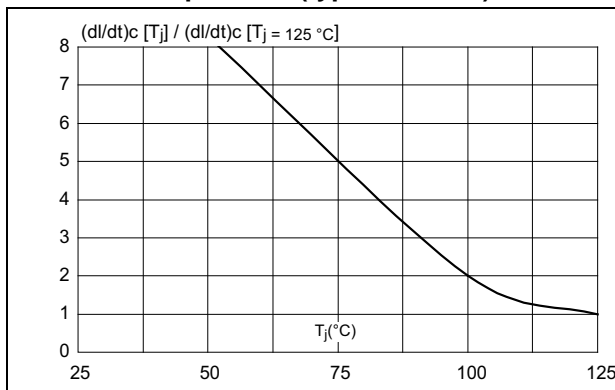

Figure 10. Relative variation of critical rate of decrease of main current versus reapplied dV/dt

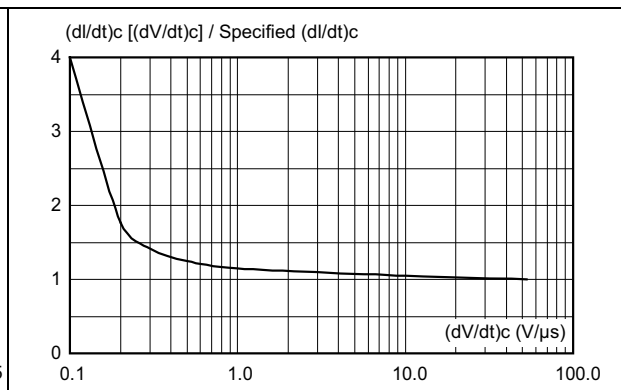

Figure 11. Non repetitive surge peak on-state current for a sinusoidal pulse with width $t_p < 10$ ms

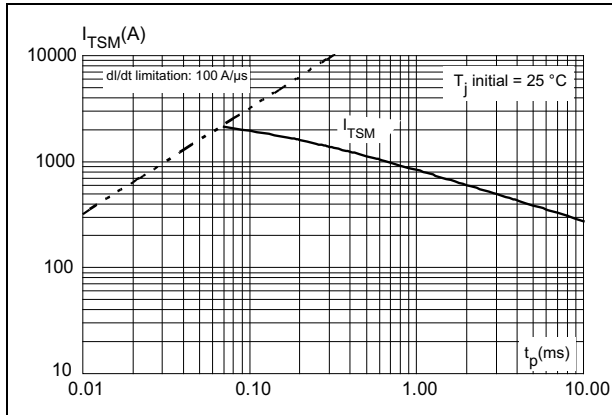

Figure 12. On-state characteristics (maximum values)

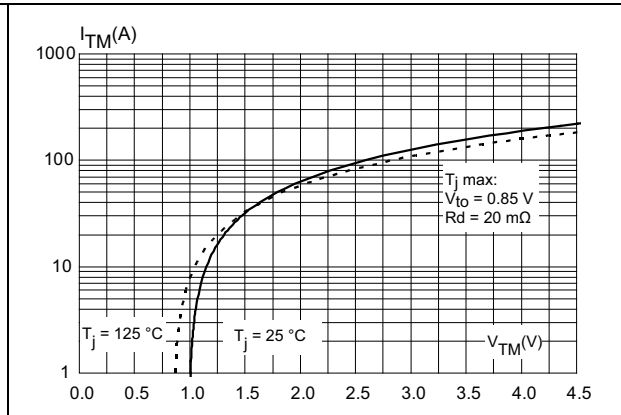

Figure 13. Relative variation of leakage current versus junction temperature for different values of blocking voltage (typical values)

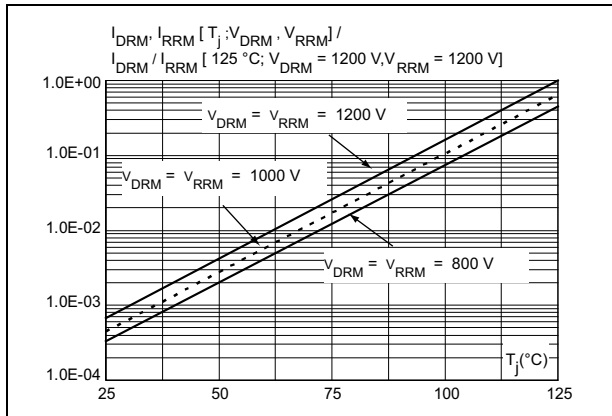
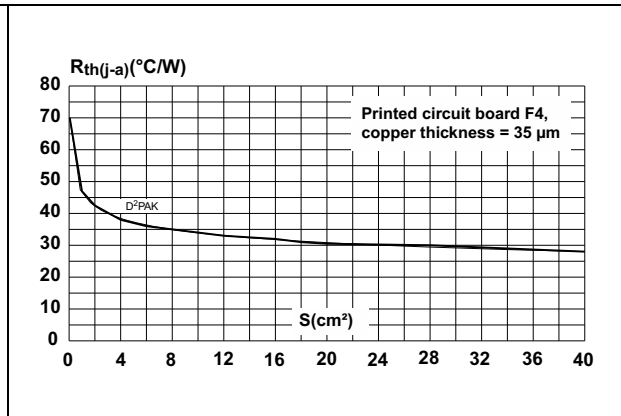

Figure 14. D²PAK thermal resistance junction to ambient versus copper surface under tab



2 Package information

- Epoxy meets UL94, V0
- Lead-free package leads, halogen-free molding resin
- Recommended torque: 0.4 to 0.6 N·m

In order to meet environmental requirements, ST offers these devices in different grades of ECOPACK® packages, depending on their level of environmental compliance. ECOPACK® specifications, grade definitions and product status are available at: www.st.com. ECOPACK® is an ST trademark.

2.1 TO-220AB (insulated and non-insulated) information

Figure 15. TO-220AB (insulated and non-insulated) package outline

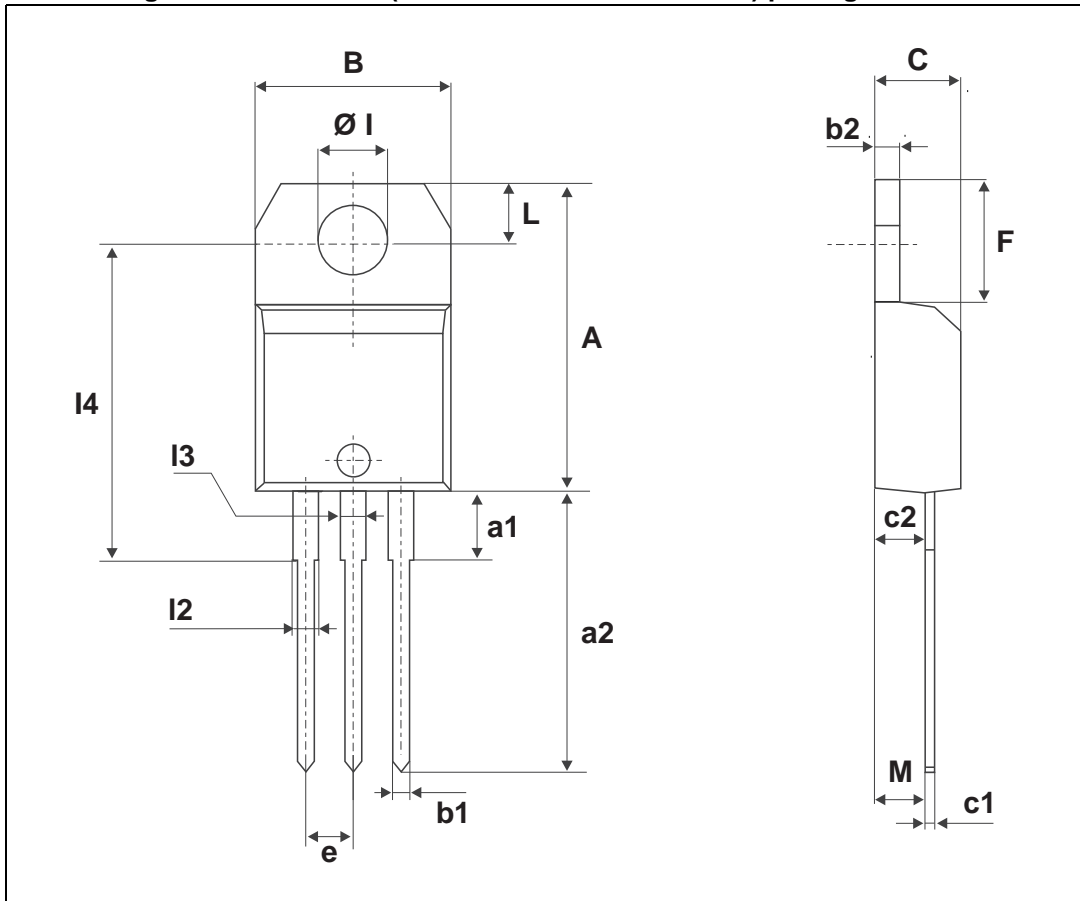

Table 6. TO-220AB (insulated and non-insulated) package mechanical data

Ref.	Dimensions					
	Millimeters			Inches		
	Min.	Typ.	Max.	Min.	Typ.	Max.
A	15.20		15.90	0.5984		0.6259
a1		3.75			0.1476	
a2	13.00		14.00	0.5118		0.5511
B	10.00		10.40	0.3937		0.4094
b1	0.61		0.88	0.0240		0.0346
b2	1.23		1.32	0.0484		0.0519
C	4.40		4.60	0.1732		0.1811
c1	0.49		0.70	0.0192		0.0275
c2	2.40		2.72	0.0944		0.1070
e	2.40		2.70	0.0944		0.1062
F	6.20		6.60	0.2440		0.2598
ØI	3.73		3.88	0.1468		0.1527
I4	15.80	16.40	16.80	0.6220	0.6456	0.6614
L	2.65		2.95	0.1043		0.1161
I2	1.14		1.70	0.0448		0.0669
I3	1.14		1.70	0.0448		0.0669
M		2.60			0.1023	

2.2 D²PAK package information

Figure 16. D²PAK package outline

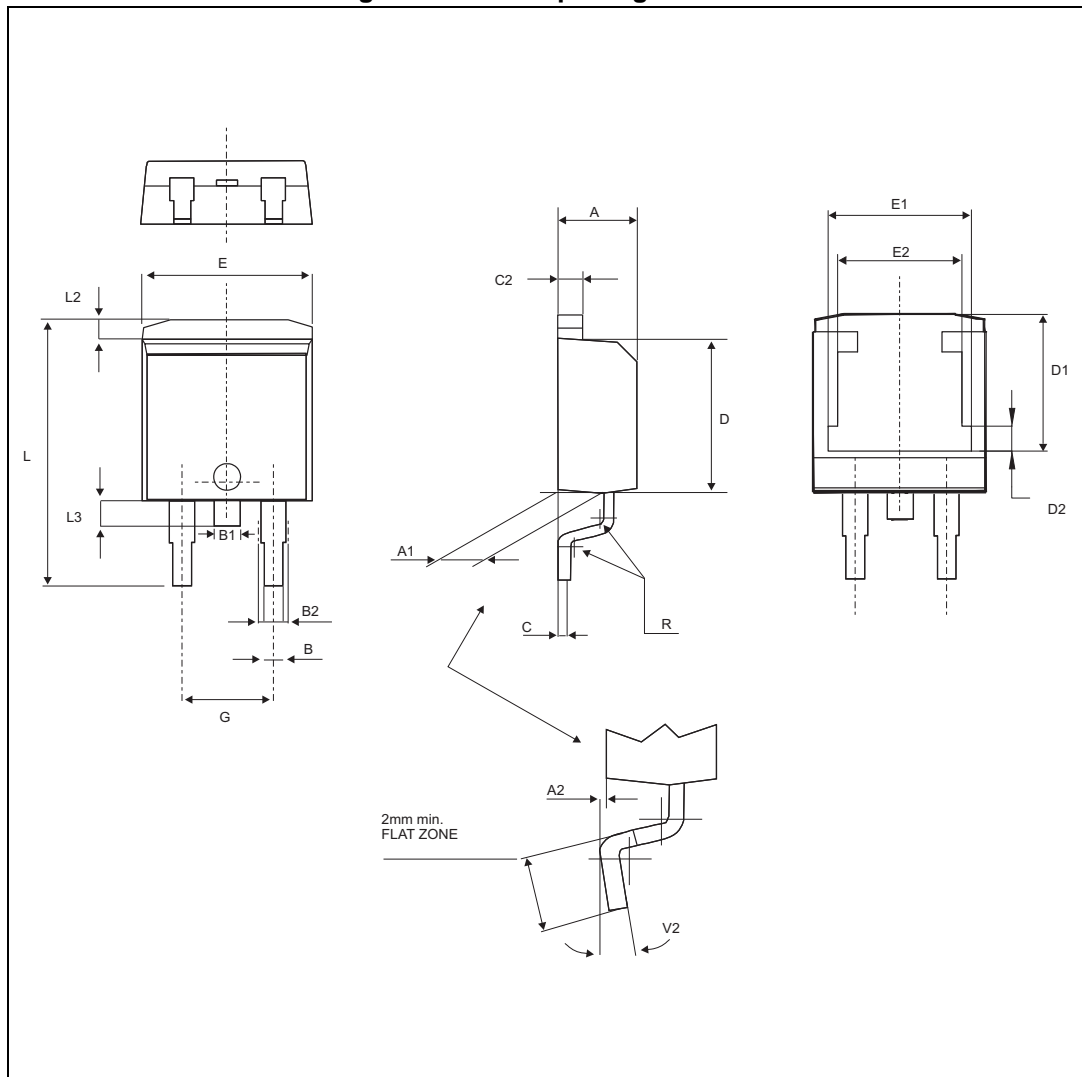
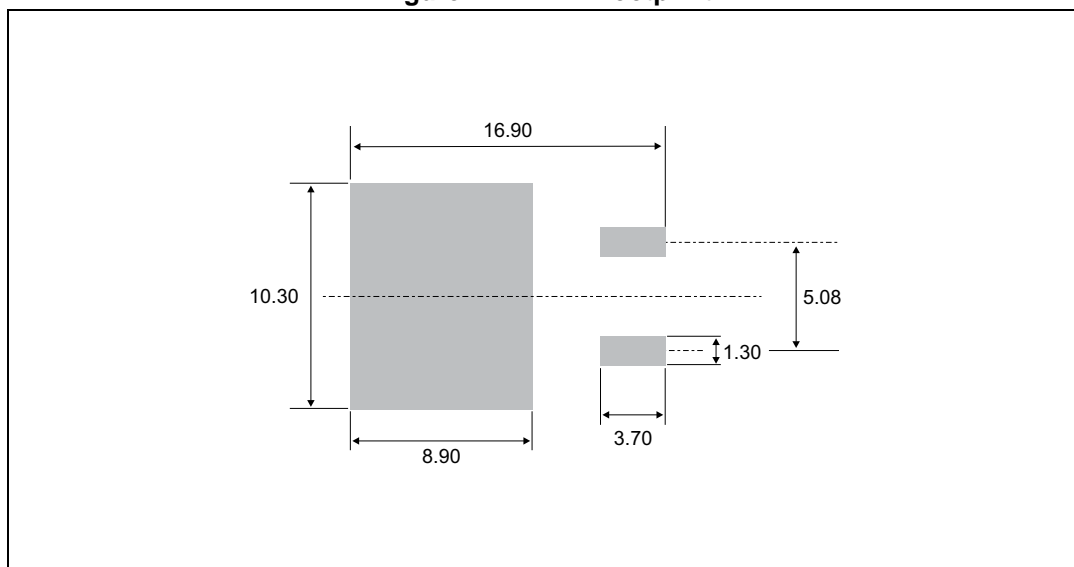

Table 7. D²PAK package mechanical data

Ref.	Dimensions					
	Millimeters			Inches		
	Min.	Typ.	Max.	Min.	Typ.	Max.
A	4.30		4.60	0.1692		0.1811
A1	2.49		2.69	0.0980		0.1059
A2	0.03		0.23	0.0011		0.0090
B	0.70		0.93	0.0275		0.0366
B2	1.25	1.40		0.0492	0.0551	
C	0.45		0.60	0.0177		0.0236
C2	1.21		1.36	0.0476		0.0535
D	8.95		9.35	0.3523		0.3681
D1	7.5		8.0	0.295		0.314
D2	1.3		1.7	0.051		0.066
E	10.00		10.28	0.3937		0.4047
E1	8.3		8.7	0.326		0.342
E2	6.85		7.25	0.2696		0.2854
G	4.88		5.28	0.1921		0.2078
L	15.00		15.85	0.5905		0.6240
L2	1.27		1.40	0.05		0.0551
L3	1.40		1.75	0.0551		0.0688
R	0.40			0.0157		
V2	0°		8°	0°		8°

Figure 17. D²PAK footprint



3 Ordering information

Figure 18. Ordering information scheme

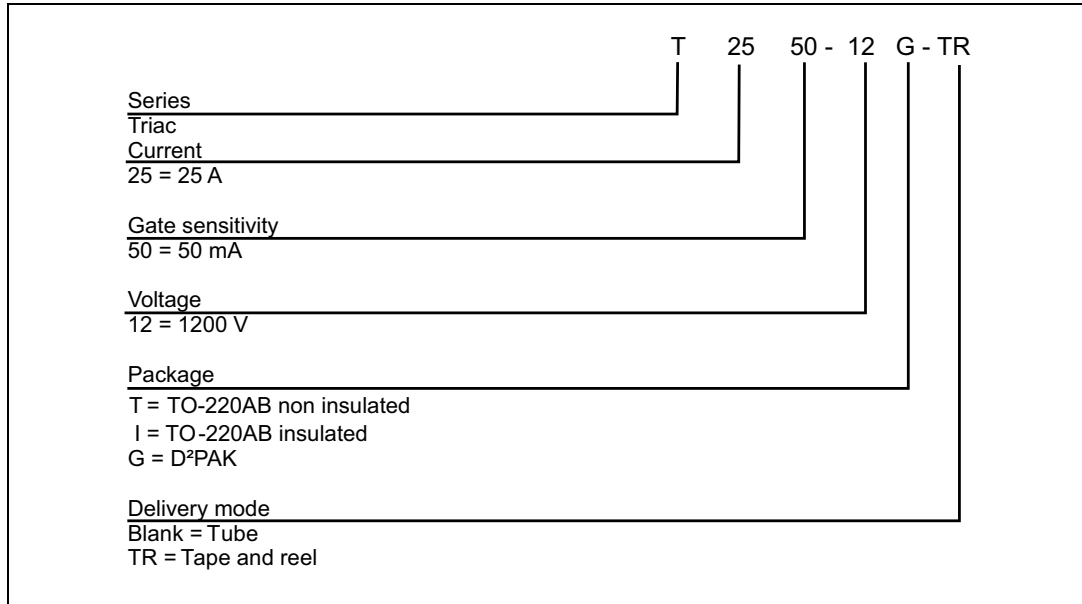

Table 8. Ordering information

Order code	Marking	Package	Weight	Base qty	Delivery mode
T2550-12G	T2550-12G	D ² PAK	1.5 g	50	Tube
T2550-12G-TR			1.5 g	1000	Tape and reel 13"
T2550-12T	T2550-12T	TO-220AB	2.3	50	Tube
T2550-12I	T2550-12I	TO-220AB Ins.	2.3 g	50	Tube

4 Revision history

Table 9. Document revision history

Date	Revision	Changes
09-Jan-2014	1	Initial release.
30-Jan-2014	2	Updated Table 4.
10-Dec-2015	3	Inserted TO-220AB insulated package information and reformatted to current standard.

IMPORTANT NOTICE – PLEASE READ CAREFULLY

STMicroelectronics NV and its subsidiaries ("ST") reserve the right to make changes, corrections, enhancements, modifications, and improvements to ST products and/or to this document at any time without notice. Purchasers should obtain the latest relevant information on ST products before placing orders. ST products are sold pursuant to ST's terms and conditions of sale in place at the time of order acknowledgement.

Purchasers are solely responsible for the choice, selection, and use of ST products and ST assumes no liability for application assistance or the design of Purchasers' products.

No license, express or implied, to any intellectual property right is granted by ST herein.

Resale of ST products with provisions different from the information set forth herein shall void any warranty granted by ST for such product.

ST and the ST logo are trademarks of ST. All other product or service names are the property of their respective owners.

Information in this document supersedes and replaces information previously supplied in any prior versions of this document.

© 2015 STMicroelectronics – All rights reserved