

TOOLSTICK C8051F850 DAUGHTER CARD USER'S GUIDE

1. Handling Recommendations

To enable development, the ToolStick Base Adapter and daughter cards are distributed without any protective plastics. To prevent damage to the devices and/or the host PC, consider the following recommendations when using the ToolStick:

- Never connect or disconnect a daughter card to or from the ToolStick Base Adapter while the Base Adapter is connected to a PC.
- Always connect and disconnect the ToolStick Base Adapter from the PC by holding the edges of the boards.

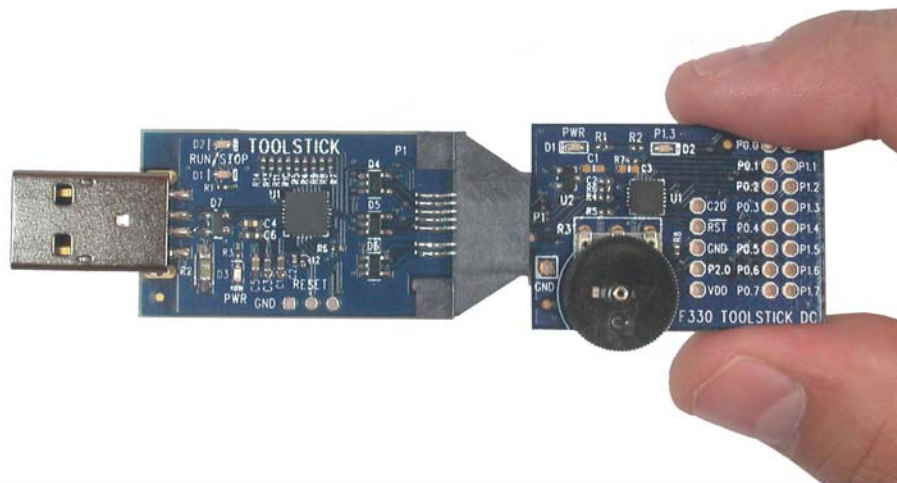

Figure 1. Proper Method of Holding the ToolStick

- Avoid directly touching any of the other components.

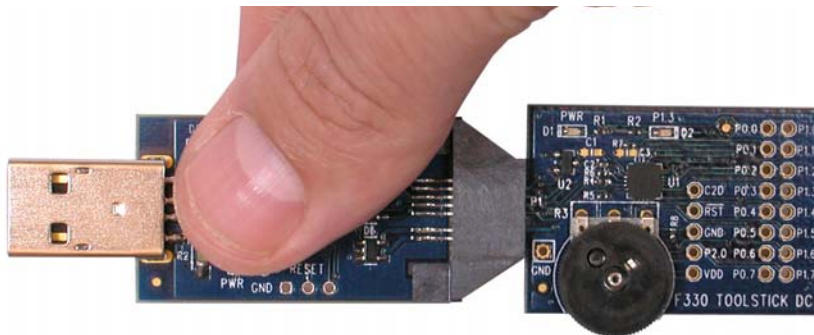

Figure 2. Improper Method of Holding the ToolStick

- Manipulate mechanical devices on the daughter cards, such as potentiometers, with care to prevent the Base Adapter or daughter card from accidentally dislodging from their sockets.

TOOLSTICK850DC-UG

2. Contents

The C8051F850 ToolStick Daughter Card kit (**TOOLSTICK850-B-DC**) contains the following items:

- ToolStick C8051F850 Daughter Card (**TOOLSTICK850DC**)

A ToolStick daughter card requires a ToolStick Base Adapter to communicate with the PC. ToolStick Base Adapters can be purchased at www.silabs.com/toolstick.

The C8051F850 ToolStick Starter Kit (**TOOLSTICK850-B-SK**) contains the following items:

- ToolStick C8051F850 Daughter Card (**TOOLSTICK850DC**)
- ToolStick Base Adapter (**TOOLSTICKBA**)
- USB extension cable

3. ToolStick Overview

The purpose of the ToolStick is to provide a development and demonstration platform for Silicon Labs microcontrollers and to demonstrate the Silicon Labs Simplicity Studio software tools.

The ToolStick development platform consists of two components: the ToolStick Base Adapter and a daughter card. The ToolStick Base Adapter provides a USB debug interface and data communications path between a Windows PC and a target microcontroller.

The target microcontroller and application circuitry are located on the daughter card. Some daughter cards, such as the C8051F850 Daughter Card, are used as general-purpose development platforms for the target microcontrollers and some are used to demonstrate a specific feature or application.

The C8051F850 Daughter Card includes a pair of GPIO-controlled LEDs, a potentiometer, two switches connected to GPIO, and a small prototyping area which provides access to all of the pins of the device. This prototyping area can be used to connect additional hardware to the microcontroller and use the daughter card as a development platform.

Figure 3 shows the ToolStick C8051F850 Daughter Card and identifies the various components.

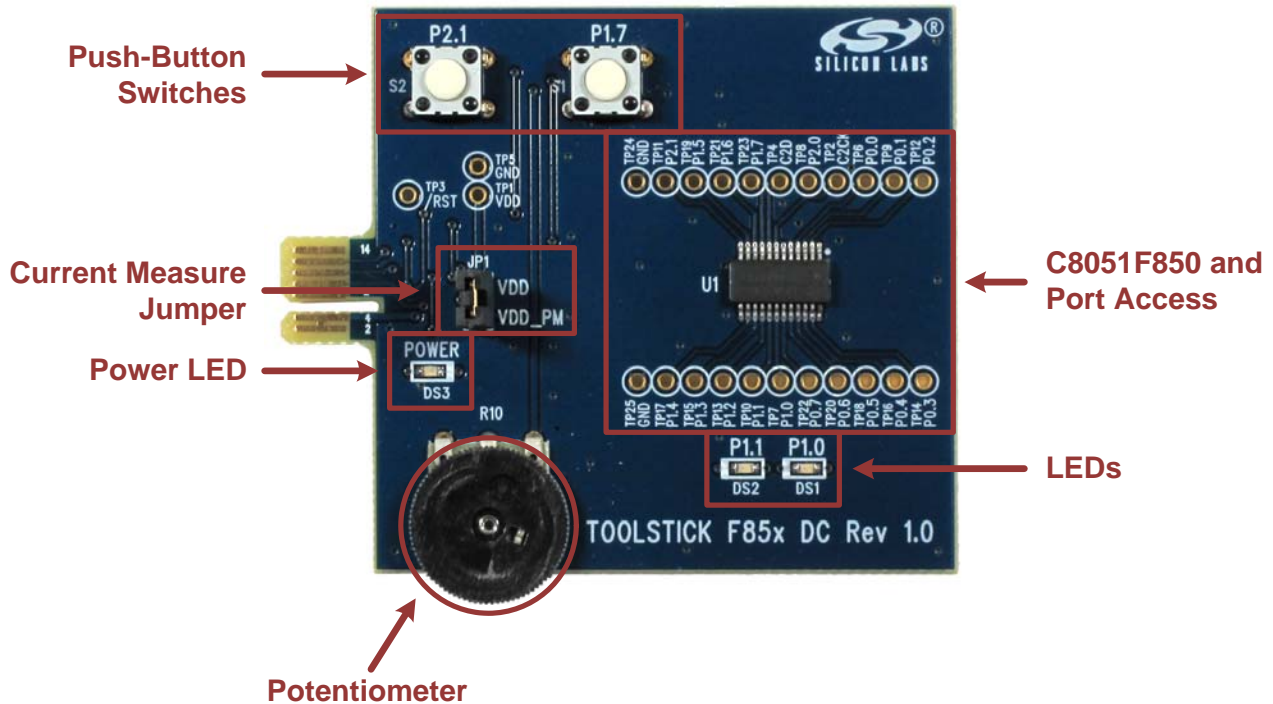

Figure 3. ToolStick C8051F850 Daughter Card

4. Getting Started

The necessary software to download, debug, and communicate with the target microcontroller must be downloaded from www.silabs.com/toolstick. The following software is necessary to build a project, download code to, and communicate with the target microcontroller:

- **Simplicity Studio**
- **Keil C51 Tools**
- **ToolStick Development Tools**

The software described above is provided in the Simplicity Studio and 8-bit microcontroller studio download packages. The **ToolStick Development Tools** selection includes example code specifically for the ToolStick daughter card, documentation including user's guides and data sheets, and the ToolStick Terminal application. After downloading and installing these packages, see the following sections for information regarding the software and running one of the demo applications.

5. Software Overview

Simplicity Studio greatly reduces development time and complexity with Silicon Labs EFM32 and 8051 MCU products by providing a high-powered IDE, tools for hardware configuration, and links to helpful resources, all in one place.

Once Simplicity Studio is installed, the application itself can be used to install additional software and documentation components to aid in the development and evaluation process.

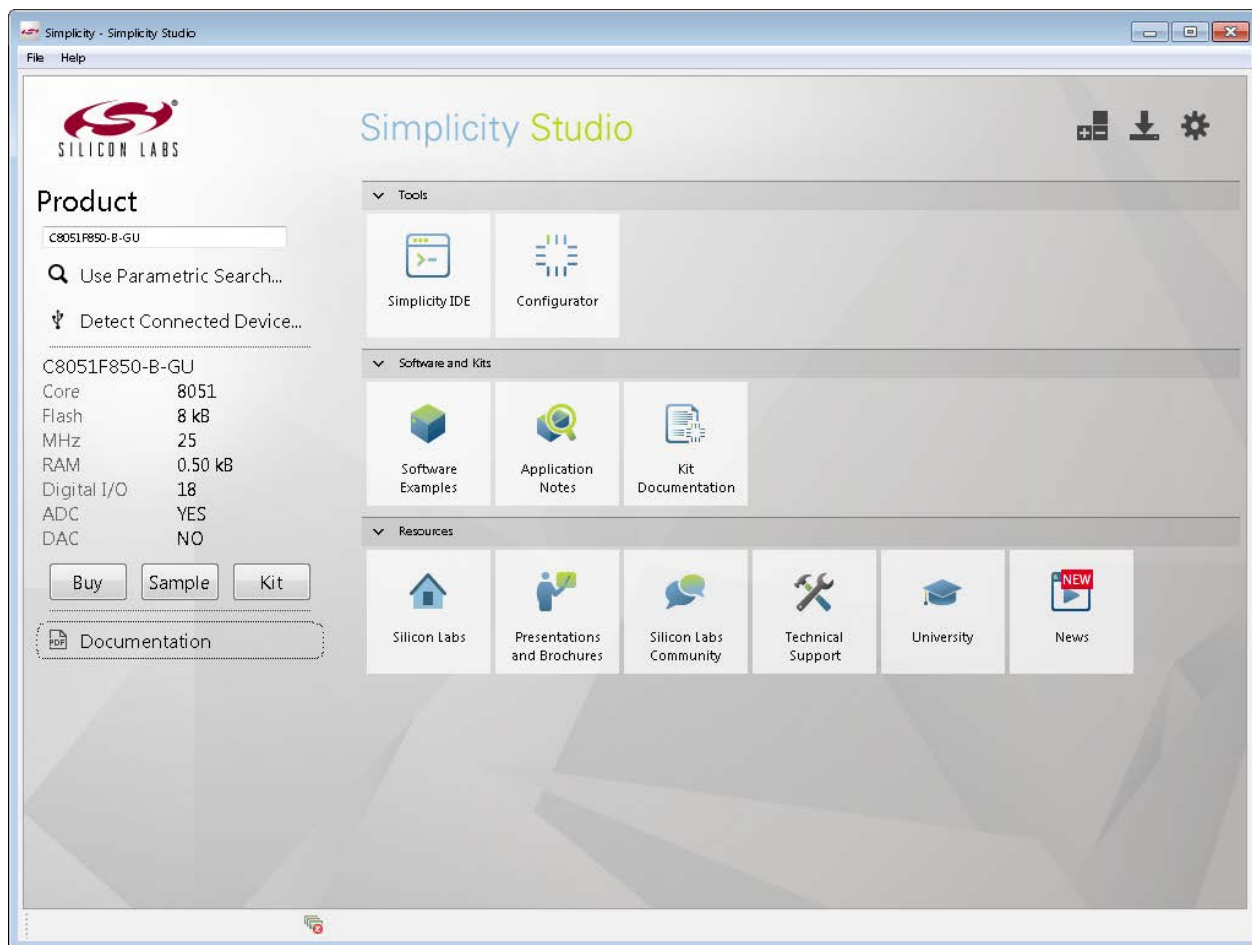

Figure 4. Simplicity Studio

TOOLSTICK850DC-UG

The following Simplicity Studio components are required for the C8051F850 ToolStick Starter Kit:

- 8051 Products Part Support
- Simplicity Developer Platform

Download and install Simplicity Studio from www.silabs.com/8bit-software or www.silabs.com/simplicity-studio. Once installed, run Simplicity Studio by selecting **Start**→**Silicon Labs**→**Simplicity Studio**→**Simplicity Studio** from the start menu or clicking the **Simplicity Studio** shortcut on the desktop. Follow the instructions to install the software and click **Simplicity IDE** to launch the IDE.

The first time the project creation wizard runs, the **Setup Environment** wizard will guide the user through the process of configuring the build tools and SDK selection.

In the **Part Selection** step of the wizard, select from the list of installed parts only the parts to use during development. Choosing parts and families in this step affects the displayed or filtered parts in the later device selection menus. Choose the C8051F85x family by checking the **C8051F85x/86x** check box. Modify the part selection at any time by accessing the **Part Management** dialog from the **Window**→**Preferences**→**Simplicity Studio**→**Part Management** menu item.

Simplicity Studio can detect if certain toolchains are not activated. If the **Licensing Helper** is displayed after completing the **Setup Environment** wizard, follow the instructions to activate the toolchain.

5.1. Running Blinky

Each project has its own source files, target configuration, SDK configuration, and build configurations such as the **Debug** and **Release** build configurations. The IDE can be used to manage multiple projects in a collection called a workspace. Workspace settings are applied globally to all projects within the workspace, and can include settings such as key bindings, window preferences, and code style and formatting options. Project actions such as build and debug are context sensitive. For example, the user must select a project in the **Project Explorer** view in order to build that project.

To create a project based on the Blinky example:

1. Click the **Simplicity IDE** tile from the Simplicity Studio home screen.
2. Click the **Create new project** link from the welcome screen or go to **File**→**New**→**Silicon Labs MCU Project**.
3. In the **Kit** drop-down, select **C8051F850 ToolStick Starter Kit**, in the **Part** drop-down, select **C8051F850**, and in the **SDK** drop-down, select the desired SDK. Click **Next**.
4. Select **Example** and click **Next**.
5. Under **C8051F850 ToolStick Starter Kit** in the **Blinky** folder, select **F85x-86x Blinky** and click **Finish**.
6. Click on the project in the **Project Explorer** and click **Build**, the hammer icon in the top bar. Alternatively, go to **Project**→**Build Project**.
7. Click **Debug** to download the project to the hardware and start a debug session.
8. Press the **Resume** button to start the code running. The LED should blink.



9. Press the **Suspend** button to stop the code.



10. Press the **Reset the device** button to reset the target MCU.



11. Press the **Disconnect** button to return to the development perspective.



5.2. Simplicity Studio Help

Simplicity Studio includes detailed help information and device documentation within the tool. The help contains descriptions for each dialog window. To view the documentation for a dialog, click the question mark icon in the window:



This will open a pane specific to the dialog with additional details.

The documentation within the tool can also be viewed by going to **Help**→**Help Contents** or **Help**→**Search**.

5.3. Simplicity Configurator

The Simplicity Configurator is a configuration and code generation tool. This utility helps accelerate development by automatically generating initialization source code to configure and enable the on-chip resources needed by most design projects. In just a few steps, the wizard creates complete startup code for a specific Silicon Labs MCU. To create a new Simplicity Configurator project:

1. Click the **Create new project** link from the welcome screen or go to **File**→**New**→**Silicon Labs MCU Project**.
2. In the **Kit** drop-down, select **C8051F850 ToolStick Starter Kit** or **None**, in the **Part** drop-down, select **C8051F850**, and in the **SDK** drop-down, select the desired SDK. Click **Next**.
3. Select **Simplicity Configurator Program** and click **Next**.
4. Fill in the **Project name** and select the desired device. The **C8051F850-C-GU-QSOP** device is on the C8051F850 ToolStick. Click **Finish**.

The Simplicity Configurator project displays properties for each peripheral. To configure a peripheral, click on the **DefaultMode Peripherals** tab at the bottom and click on a peripheral. Checking the box for a peripheral will add it to code generation. Once a peripheral is selected, configure the registers using the **Properties** view. Select a new value for a property with either an input box or a drop-down menu and press **Enter** to set it.

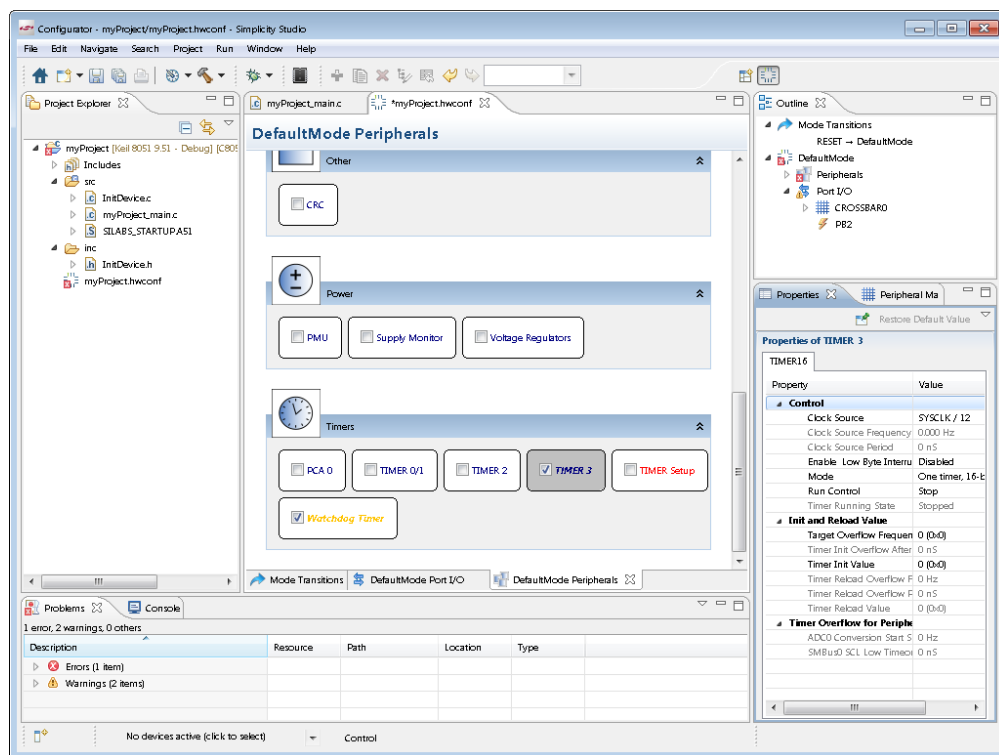

Figure 5. Simplicity Configurator – Configuring Peripheral Properties

TOOLSTICK850DC-UG

To configure pins, click on the **DefaultMode Port I/O** tab at the bottom of main window. Clicking on a pin brings up a property window for the pin. Clicking anywhere else in the main window opens a property window for the crossbar. Select multiple pins with **Ctrl + left click** or mouse dragging over the desired set of pins. The package diagram displays the configured peripherals on the pins, including non-crossbar signals (i.e., ADC inputs).

Code generation updates every time the configuration project saves. After configuring the device, add any non-initialization code, build, and debug the same as with any other project.

More information on Simplicity Configurator can be found in **AN0823: Simplicity Configurator User's Guide** and **AN0821: Simplicity Studio C8051F85x Walkthrough**. Application notes can be found on www.silabs.com/8bit-appnotes.

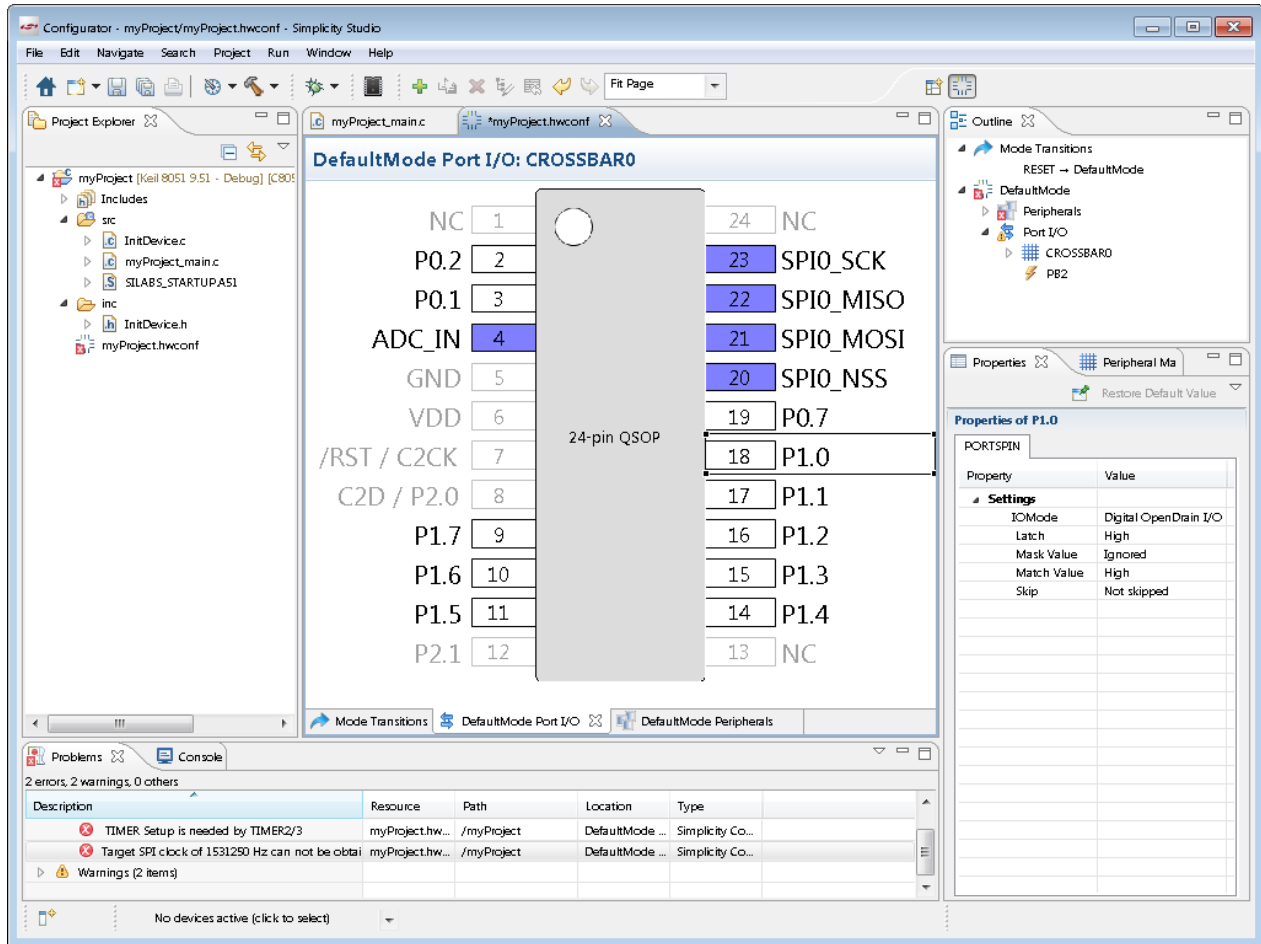

Figure 6. Simplicity Configurator – Configuring Port I/O

5.4. Legacy 8-bit IDE

Note: Using the Simplicity Studio tools with the C8051F850 ToolStick is recommended. See "5. Software Overview," on page 3 for more information.

Download the 8-bit software from the website (www.silabs.com/8bit-software) to install the software tools for the ToolStick-F850DC devices. After installation, examples can be found in `...\Examples\C8051F85x_86x` in the installation directory. At a minimum, the C8051F850 ToolStick requires:

- **Silicon Labs IDE**—Software enabling initial evaluation, development, and debugging.
- **Keil C51 Tools**—Keil 8051 Compiler/Assembler/Linker toolchain.
- **ToolStick Development Tools**—Software and examples for the ToolStick development platform. More information on this platform can be found at www.silabs.com/toolstick.

Other software available includes:

- **Keil μ Vision Driver**—Driver for the Keil μ Vision IDE that enables development and debugging on C8051Fxxx MCUs.
- **Flash Programming Utilities and MCU Production Programmer**—Programming utilities for the production line. More information on the available programming options can be found on the website: www.silabs.com/products/mcu/Pages/ProgrammingOptions.aspx.

The development kit includes the latest version of the C51 Keil 8051 toolset. This toolset is initially limited to a code size of 2 kB and programs start at code address 0x0800. After registration, the code size limit is removed entirely and programs will start at code address 0x0000.

To register the Keil toolset:

1. Register on the Silicon Labs website (www.silabs.com/8bit-software) to obtain the serial number.
2. Open the Keil μ Vision4 IDE from the installation directory with administrative privileges.
3. Select **File**→**License Management** to open the License Management window.

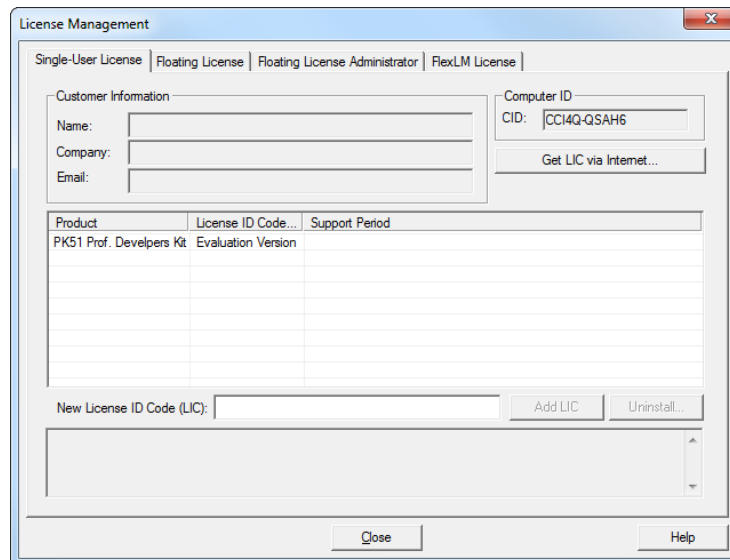

Figure 7. Keil μ Vision4 IDE License Management Window

4. Click on the **Get LIC via Internet...** button to open the Obtaining a License IDE Code (LIC) window.
5. Press **OK** to open a browser window to the Keil website. If the window doesn't open, navigate to www.keil.com/license/install.htm.
6. Enter the Silicon Labs **Product Serial Number**, along with any additional required information.
7. Once the form is complete, click the **Submit** button. An email will be sent to the provided email address with the license activation code.

TOOLSTICK850DC-UG

8. Copy the License ID Code (LIC) from the email.
9. Paste the LIC into the **New License ID Code (LIC)** text box at the bottom of the License Management window in μ Vision4.
10. Press the **Add LIC** button. The window should now list the **PK51 Prof. Developers Kit for Silabs** as a licensed product.
11. Click the **Close** button.

5.5. ToolStick Terminal

The ToolStick Terminal program provides the standard terminal interface to the target microcontroller's UART. However, instead of requiring the usual RS-232 and COM port connection, ToolStick Terminal uses the USB interface of the ToolStick Base Adapter to provide the same functionality. The software is available on the ToolStick webpage (www.silabs.com/toolstick).

In addition to the standard terminal functions (send file, receive file, change baud rate), two GPIO pins on the target microcontroller can be controlled using the Terminal for either RTS/CTS handshaking or software-configurable purposes.

To use the ToolStick Terminal program:

1. Download an example to the ToolStick device that uses UART communication. One example of this type is the **F85x-86x STDIO** example in the **UART** folder from the Simplicity Studio example project creation wizard.
2. Disconnect from the device in the Simplicity IDE. The IDE and the ToolStick Terminal cannot communicate with the daughter card simultaneously.
3. Open ToolStick Terminal from the **Start** → **Programs** → **Silicon Labs** menu.

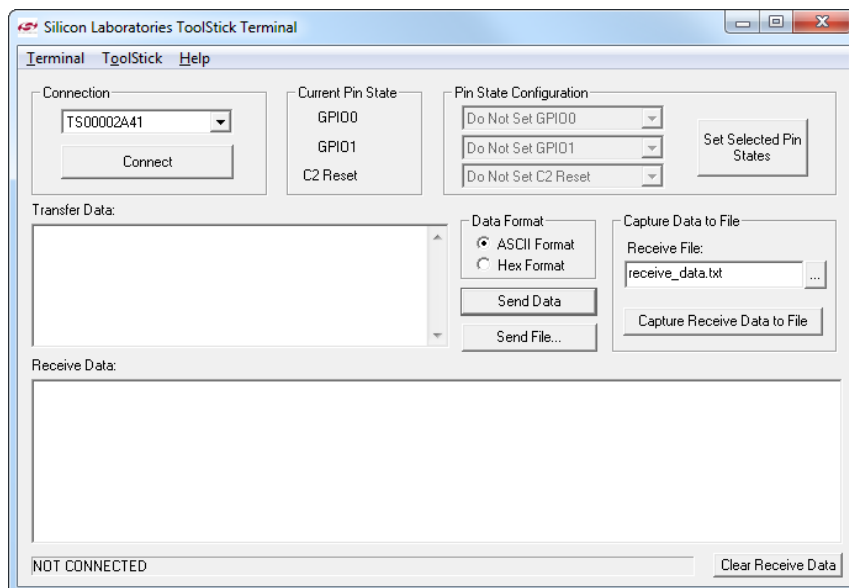

4. In the top, left-hand corner of the Terminal application, available devices are shown in the drop-down Connection menu. Click **Connect** to connect to the device.
5. If using the **F85x-86x STDIO** example, text printed from the device will appear in the **Receive Data** window.
6. Type in a value in the **Transfer Data** window and press the **Send Data** button. The firmware will echo the value entered, print the value in hexadecimal, and prompt for a new value.

In addition to the standard two UART pins (TX and RX), there are two GPIO/UART handshaking pins on the ToolStick Base Adapter that are connected to two port pins on the target microcontroller. ToolStick Terminal is used to configure and read/write these pins. Under **Pin State Configuration** area in ToolStick Terminal, select the

desired state from the drop-down menu and click the **Set Selected Pin States** button.

The firmware on the C8051F850 target microcontroller does not need to be customized to use the UART and communicate with ToolStick Terminal. The firmware on the microcontroller should write to the UART as it would in any standard application, and all of the translation is handled by the ToolStick Base Adapter.

6. Using the C8051F850 Daughter Card as a Development Platform

The prototyping area on the ToolStick C8051F850 Daughter Card makes it easy to interface to external hardware. All of the digital I/O pins are available, so it is possible to create a complete system.

6.1. C8051F850 Pin Connections

It is important to note that if external hardware is being added, some of the existing components on the board can interfere with the signaling. The following is a list of port pins on the C8051F850 that are connected to other components:

Table 1. ToolStick Daughter Card Pin Functions

MCU Pin	ToolStick Daughter Card Function
P0.0	
P0.1	
P0.2	
P0.3	
P0.4	UART TX
P0.5	UART RX
P0.6	
P0.7	
P1.0	red LED DS1
P1.1	red LED DS2
P1.2	potentiometer R10
P1.3	
P1.4	
P1.5	GPIO0/RTS
P1.6	GPIO1/CTS
P1.7	Switch S1
P2.0	C2D Pin Sharing
P2.1	Switch S2

See the daughter card schematic in Section 7 for more information.

6.2. C2 Pin Sharing

On the C8051F850, the C2CK and C2D debug pins are shared with the /RST and P2.0 pins respectively. The daughter card includes the resistors necessary to enable pin sharing, which allows the /RST and P2.0 pins to be used normally while simultaneously debugging the device. See Application Note “AN124: Pin Sharing Techniques for the C2 Interface” at www.silabs.com/products/mcu/Pages/ApplicationNotes.aspx for more information regarding pin sharing.

7. Schematic

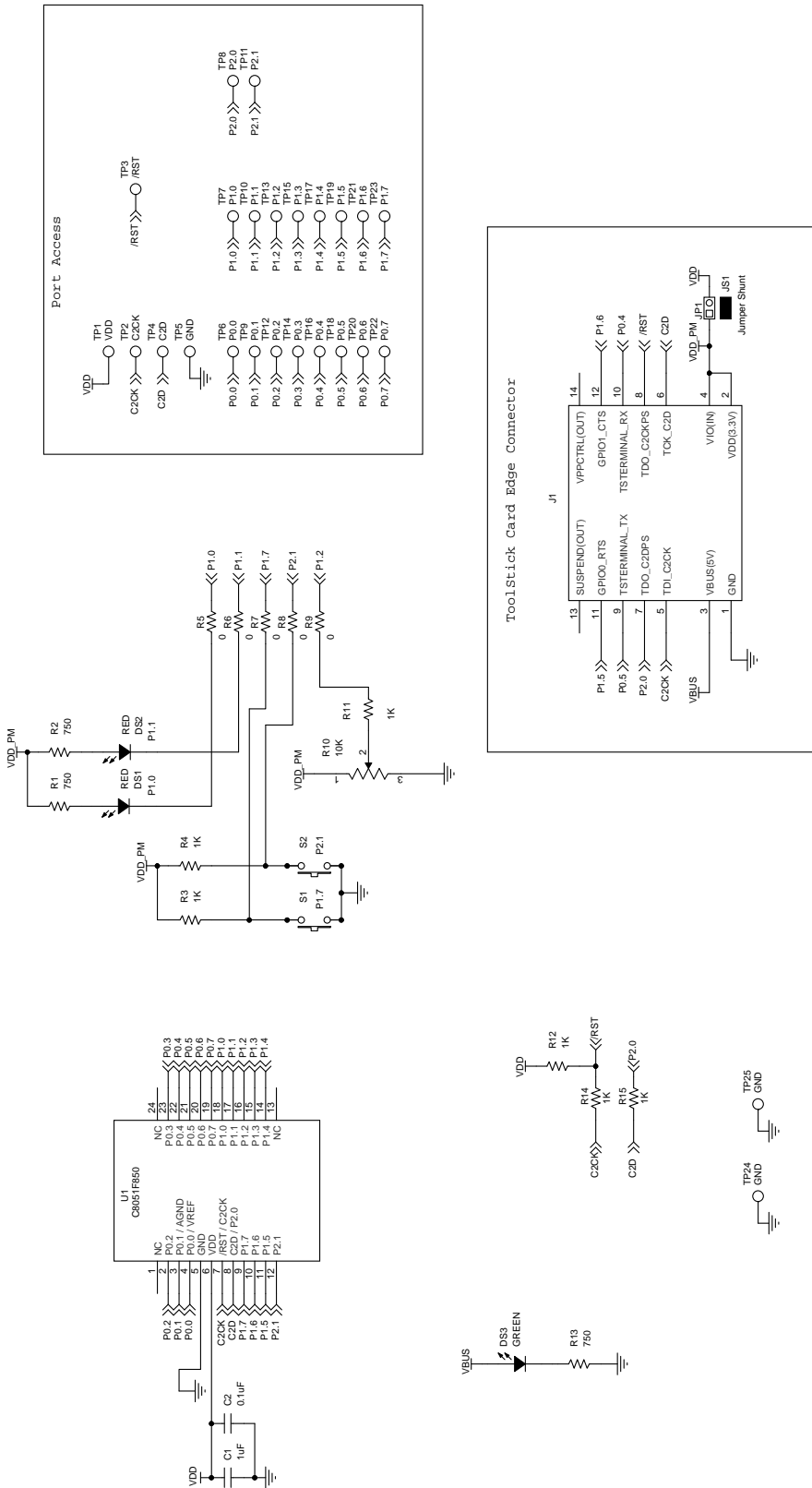

Figure 8. C8051F850 ToolStick Daughter Card Schematic Rev 1.0 (1 of 1)

8. Bill of Materials

Table 2. C8051F850 ToolStick Daughter Card Bill of Materials (Rev 1.0)

Reference	Part Number	Source	Description
C1	C0603X7R100-105K	Venkel	1 uF 10 V $\pm 10\%$ X7R 0603
C2	C0603X7R100-104K	Venkel	0.1 uF 10 V $\pm 10\%$ X7R 0603
DS1 DS2	SML-LX0603IW	Lumex Inc	RED 30mA LED 0603
DS3	SML-LX0603SUGW	Lumex Inc	GREEN 25mA LED 0603
JP1	TSW-102-07-T-S	Samtec	0.1 in. 1x2 Header
JS1	SNT-100-BK-T	Samtec	Jumper Shunt
R1 R2 R13	CR0603-16W-7500F	Venkel	750 Ω 1/10W $\pm 1\%$ ThickFilm 0603
R10	RV100F-30-4K1B-B10K-B301	Alpha (Taiwan)	10 k Ω 0.03 W 30% Thumbwheel Potentiometer
R3 R4 R11 R12 R14 R15	CR0603-10W-1001F	Venkel	1 k Ω 1/10W $\pm 1\%$ ThickFilm 0603
R5 R6 R7 R8 R9	CR0603-16W-000	Venkel	0 Ω 1A ThickFilm 0603
S1 S2	EVQ-PAD04M	Panasonic Corp	Momentary Tactile Switch
U1	C8051F850-A-GU	Silicon Labs	C8051F850 MCU QSOP-24



Simplicity Studio

One-click access to MCU and wireless tools, documentation, software, source code libraries & more. Available for Windows, Mac and Linux!



IoT Portfolio
www.silabs.com/IoT



SW/HW
www.silabs.com/simplicity



Quality
www.silabs.com/quality



Support and Community
community.silabs.com

Disclaimer

Silicon Laboratories intends to provide customers with the latest, accurate, and in-depth documentation of all peripherals and modules available for system and software implementers using or intending to use the Silicon Laboratories products. Characterization data, available modules and peripherals, memory sizes and memory addresses refer to each specific device, and "Typical" parameters provided can and do vary in different applications. Application examples described herein are for illustrative purposes only. Silicon Laboratories reserves the right to make changes without further notice and limitation to product information, specifications, and descriptions herein, and does not give warranties as to the accuracy or completeness of the included information. Silicon Laboratories shall have no liability for the consequences of use of the information supplied herein. This document does not imply or express copyright licenses granted hereunder to design or fabricate any integrated circuits. The products must not be used within any Life Support System without the specific written consent of Silicon Laboratories. A "Life Support System" is any product or system intended to support or sustain life and/or health, which, if it fails, can be reasonably expected to result in significant personal injury or death. Silicon Laboratories products are generally not intended for military applications. Silicon Laboratories products shall under no circumstances be used in weapons of mass destruction including (but not limited to) nuclear, biological or chemical weapons, or missiles capable of delivering such weapons.

Trademark Information

Silicon Laboratories Inc., Silicon Laboratories, Silicon Labs, SiLabs and the Silicon Labs logo, CMEMS®, EFM, EFM32, EFR, Energy Micro, Energy Micro logo and combinations thereof, "the world's most energy friendly microcontrollers", Ember®, EZLink®, EZMac®, EZRadio®, EZRadioPRO®, DSPLL®, ISOmodem®, Precision32®, ProSLIC®, SiPHY®, USBXpress® and others are trademarks or registered trademarks of Silicon Laboratories Inc. ARM, CORTEX, Cortex-M3 and THUMB are trademarks or registered trademarks of ARM Holdings. Keil is a registered trademark of ARM Limited. All other products or brand names mentioned herein are trademarks of their respective holders.



SILICON LABS

Silicon Laboratories Inc.
 400 West Cesar Chavez
 Austin, TX 78701
 USA

<http://www.silabs.com>