

Panasonic® EVOLTA

AAA
(LR03)

Part Number: LR03EGA
Alkaline Manganese Dioxide Battery



Industry Standard Dimensions
mm (inches)

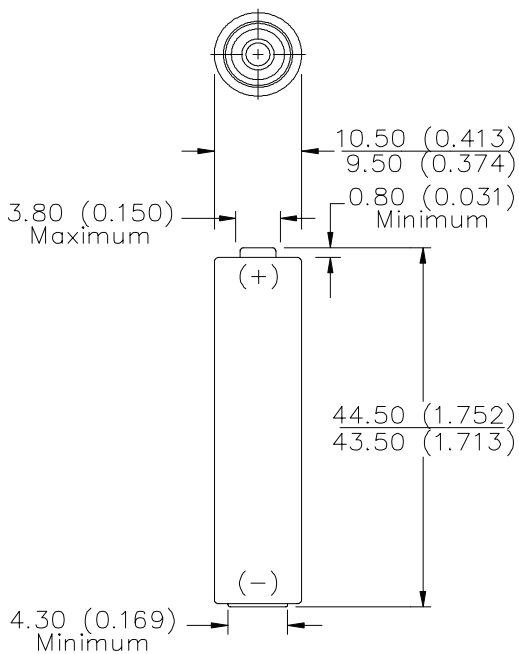

Specifications

Chemical System:	Alkaline-Zinc/Manganese Dioxide (Zn/MnO ₂)
Designation:	ANSI-24A, IEC-LR03
Nominal Voltage:	1.5 V
Operating Temperature Range:	-20°C to 54°C (-4°F to 130°F)
Typical Weight:	11 grams (0.39 oz.)
Typical Volume:	3.85 cm ³ (0.23 in. ³)
Terminals:	Cap and base
Shelf Life:	7 years (80% Capacity)
Heavy Metals Content:	No added Mercury, Cadmium or Lead

Performance Index

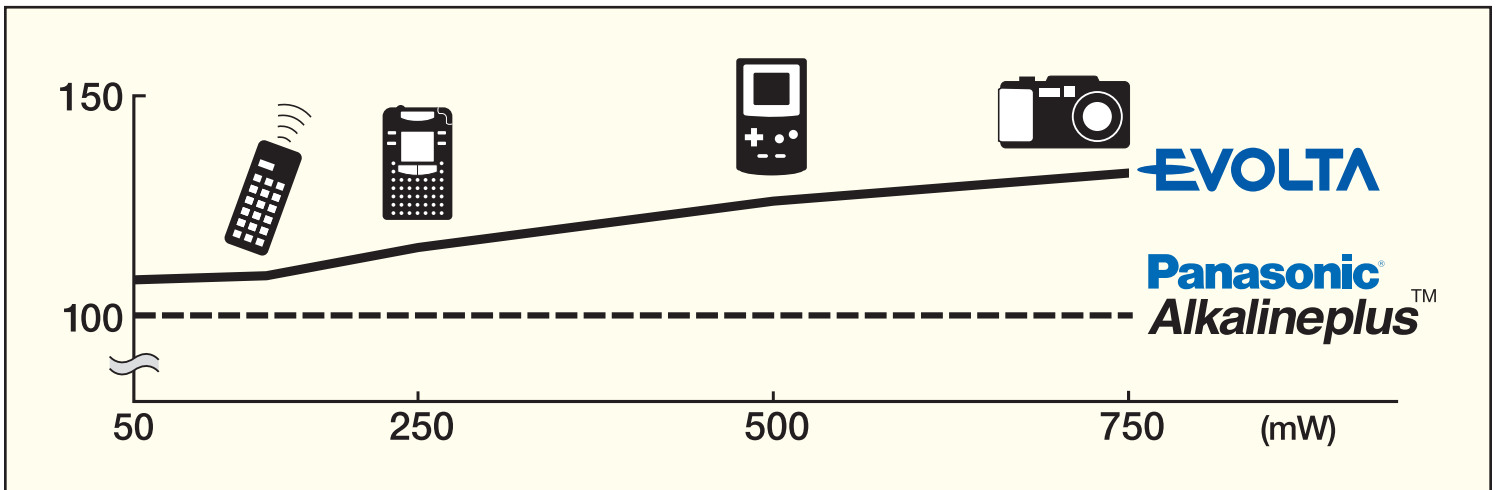

AAA

*Continuous discharge over 50 mW, 68°F, COV.1.0V

Important Notice: This data sheet contains typical information specific to products manufactured at the time of its publication.

Part Number: LR03EGA

Alkaline Manganese Dioxide Battery

IEC/ANSI Standard Tests @ 20°C

Discharge Curve of LR03 Photo Flash

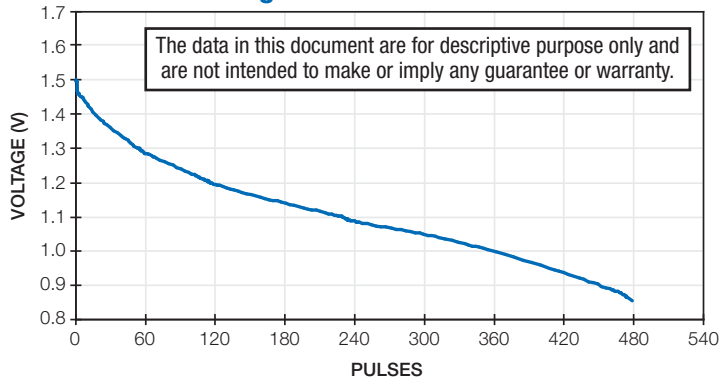

Discharge Curve of LR03 Lighting

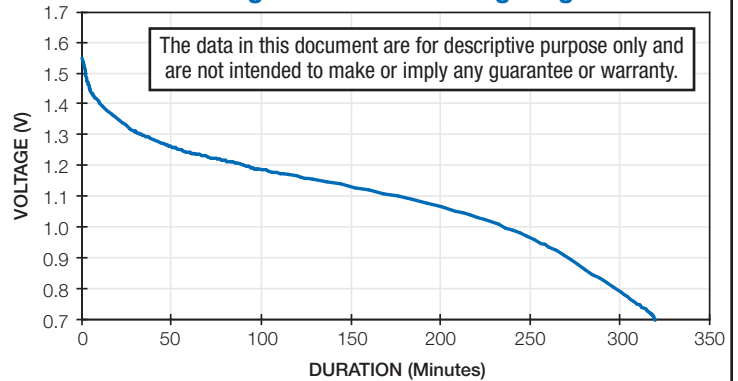

Typical Discharge Characteristics

Constant Current and Temperature Test temperature: 20±2°C

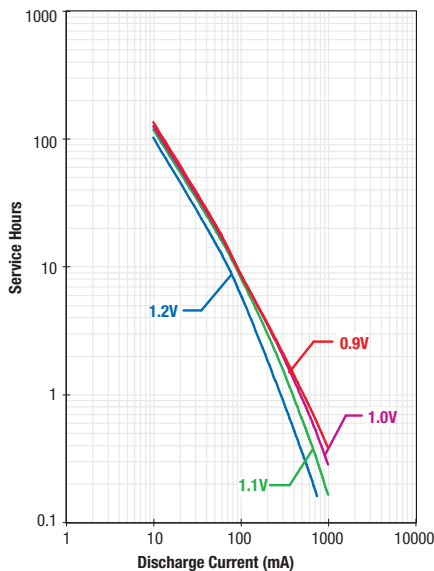

Typical Temperature Characteristics

Constant Current, Multiple Temperatures end Voltage: 0.9V

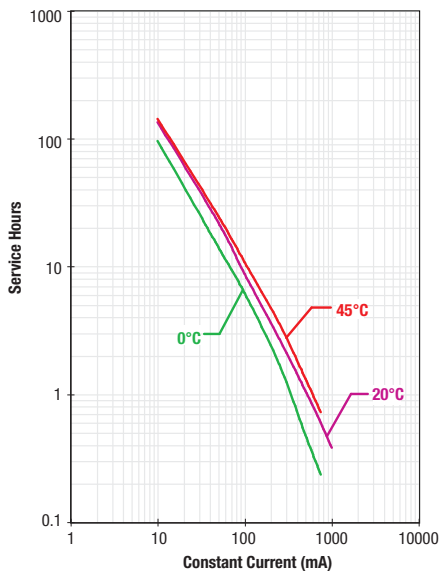

Typical Discharge Characteristics

Constant Resistance Test temperature: 20±2°C

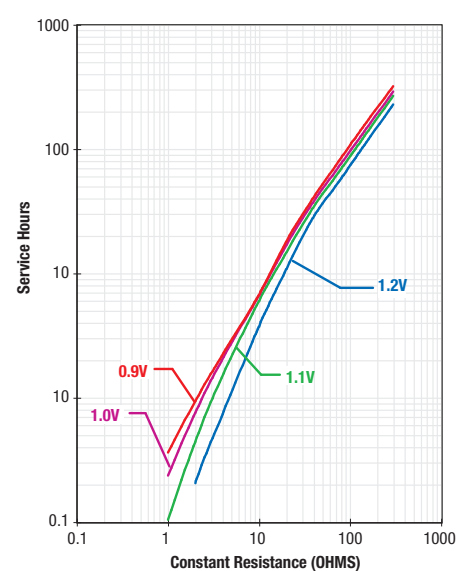

This information is generally typical and is not intended to make or imply any representation, guarantee or warranty with respect to any cells and batteries. Cell and battery designs/specifications are subject to modification without notice. Cell/battery performance and service life depends on the operating temperature, cut-off voltage and load applied to cell/battery in a specific application. It is the responsibility of each user to ensure that each cell/battery application is adequately designed safe and compatible with all conditions encountered during use and in conformance with existing standards and requirements. Contact Panasonic for the latest information.

©2008 Panasonic Energy Corporation of America. All rights reserved. All reproductions prohibited without proper authorization. Characteristics and specifications subject to change without prior notification.

Panasonic® ideas for life