

Peak Emission Wavelength: 1200nm

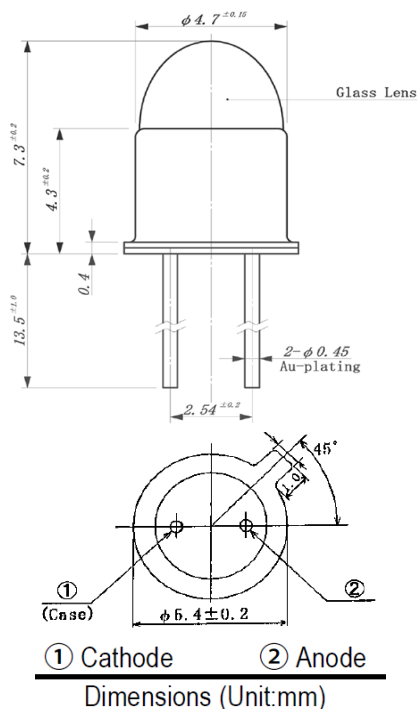

Description

- TO-46 with glass lens cap
- Type: InGaAs/InP, MQW
- High power
- High speed
- Narrow beam angle
- High reliability

Application

- Optical switches
- Optical communication
- Safety equipment
- Automation

Absolute Maximum Ratings (Ta=25°C)



ITEMS	TEST CONDITIONS	SYMBOL	RATINGS	UNIT
Forward DC Current		If	100	mA
Peak Forward Current (pulse)	t ≤ 50us, T = 100us	Ifp	200	mA
Reverse Voltage	Ir=10uA	Vr	5	V
Power Dissipation		Po	115	mW
Operating Temperature Range		Top	-20 to +85	°C
Storage Temperature Range		Tst	-30 to +100	°C
Lead Soldering Temperature	t < 5sec, 3mm from case	Tslg	260	°C
Junction Temperature		Tj	100	°C

Electrical & Optical Characteristics (Ta = 25°C)

ITEMS	SYMBOL	CONDITIONS	MIN	TYP	MAX	UNIT
Forward Voltage	Vf	If=20mA	--	0.9	1.0	V
Forward Voltage	Vf	If=100mA	--	1.0	1.2	V
Radiant Power	Φ_e	If=20mA	1.1	1.5	--	mW
Radiant Power	Φ_e	If=100mA	--	7	--	mW
Peak Wavelength	λ_p	If=20mA	1170	1200	1230	nm
Spectral Bandwidth	$\Delta\lambda_{0.5}$	If=20mA	--	70	--	nm
Viewing Angle	φ	If=20mA	--	6	--	deg
Switching Time	tr, tf	If=20mA	--	25,40	--	ns