

TLR5

Installation, Operation, and Maintenance Manual

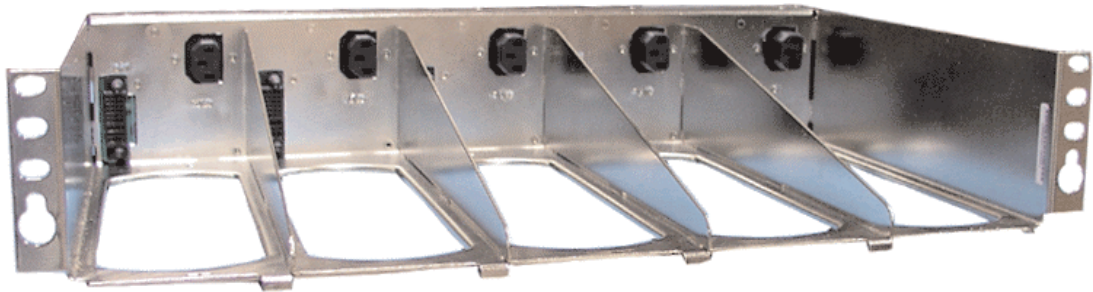

TLR5

January 2006

Version 1

LAMBDA 

Table of Contents

1) Safety and Recommended Practices	3
1.1 General practices	3
1.2 FCC Compliance Statement	4
2) Product Section	5
2.1 Heat Dissipation	5
2.2 AC Requirements	6
2.3 DC Circuit Drawings	13
2.4 DC Output Wire Sizing	14
2.5 Torque Settings	16
3) Required Tools	16
4) Site and Equipment Preparation	17
5) Power Plant Mounting and Wiring	17
5.1 Mechanical Mounting	17
5.2 AC Input	17
5.3 DC Output	20
5.4 DC Reference Ground	21
5.5 Alarms and Control	21
6) Test and Turn-up	24
6.1 Power Up	24
7) Troubleshooting	25
7.1 Problems and solutions	25
7.2 Short Circuit & Current Limit	25
8) Installationsanleitung (German Installation)	26

1 Safety and Recommended Practices

1.1 General practices

For use in restricted access locations only.
Suitable for mounting on concrete or other non-combustible surfaces

This product accepts a nominal AC voltage between 100 and 240 VAC ($\pm 10\%$), 47 to 63 Hz, and produces a regulated output of 10.5-14VDC, 21-28 VDC, or 42-56 VDC (depending upon deployed power modules) capable of delivering a max of 300 Amperes DC for 12 V power modules, max of 300 Amperes DC for 24 V power modules, or max 250 Amperes DC for 48V power modules at an ambient operating temperature range of -40°C to $+75^{\circ}\text{C}$ (depending upon deployed power modules).

HAZARDOUS VOLTAGE AND ENERGY LEVELS ARE PRESENT WHICH CAN PRODUCE SERIOUS SHOCKS AND BURNS.

Only authorized, qualified, and trained personnel should attempt to work on this equipment. Refer to datasheets for full product specifications.

Observe all local and national electrical, environmental, and workplace codes.

Each rack should be fed from a dedicated AC branch circuit of a TN power system.

If a line cord(s) is(are) used as the AC connection means, the plug end of the cord is considered to be the primary disconnect means, and reasonable access must be given to the plug and receptacle area. The receptacle must be fed with a breaker or fuse according to Table 5 (12 V), Table 6 (24 V), or Table 7 (48V).

For hard-wired AC connections, a readily accessible disconnect device shall be incorporated in the building installation wiring. Select a wall breaker and wire sizes according to Table 5 (12V), Table 6 (24V), or Table 7 (48V).

CAUTION: ALL POWER MODULES EMPLOY INTERNAL DOUBLE POLE/NEUTRAL FUSING
Internal power module fuses are not field accessible. They can be replaced only by authorized factory service personnel.

WARNING: HIGH LEAKAGE CURRENT: EARTH CONNECTION ESSENTIAL BEFORE CONNECTING SUPPLY.

Use double hole, UL listed lugs for all DC connections to prevent lug rotation and inadvertent contact with other circuits. Terminal strip connections require only single hole lugs.

Class 1, 90°C wire is recommended for all DC connections. Minimum wire sizes are shown in Table 9. In practice, loop voltage drop considerations will usually dictate larger than minimum safe wire size. Connections to multiple loads are recommended to be made through an external distribution with over-current protection.

The alarm contacts are rated for a maximum voltage of 60 V, SELV (Safety Extra Low Voltage) and a maximum continuous current of .5A.

Connection and mounting torque requirements are listed in Table 11.

Lambda does not recommend shipping the rack with the power modules installed. Power modules should be shipped in separate boxes provided by Lambda.

1.2 FCC Compliance Statement

1.2.1 Note

This device complies with Part 15 of FCC Rules. Operation is subject to the following two conditions:

1. This device may not cause harmful interference, and
2. This device must accept any interference received, including interference that may cause undesired operation.

This equipment has been tested and found to comply with the limits for a Class B digital device, pursuant to Part 15 of the FCC Rules. These limits are designed to provide reasonable protection against harmful interference in a residential installation. This equipment generates, uses, and can radiate radio frequency energy and, if not installed and used in accordance with the instructions, may cause harmful interference to radio communications. However, there is no guarantee that interference will not occur in a particular installation.

If this equipment does cause harmful interference to radio or television reception, which can be determined by turning the equipment off and on, the user is encouraged to try to correct the interference by one or more of the following measures:

- Reorient or relocate the receiving antenna.
- Increase the separation between the equipment and receiver.
- Connect the equipment into an outlet on a circuit different from that to which the receiver is connected.
- Consult the dealer or an experienced radio/TV technician for help.



1.2.2 Warning

Changes or modifications to this unit not expressly approved by the party responsible for the compliance could void the user's authority to operate this equipment.

1.2.3 ICES-003 Class B Notice

This Class B digital apparatus complies with Canadian ICES-003. Cet appareil numérique de la classe B est conforme à la norme NMB-003 du Canada.

2 Product Section

2.1 Heat Dissipation

Table 1, Table 2, and Table 3 display the max and typical BTU/hr of heat dissipated for each power module. Max is calculated at minimum AC input voltages, Max VDC and current values for power module, and typical is calculated at 240 VAC, typical VDC, and rated current values.

Heat Dissipation (12V Power Modules)		
Model	Typical BTU/hr	Max BTU/hr
TL50012	413	490
TL75012	619	718

Table 1

Heat Dissipation (24V Power Modules)		
Model	Typical BTU/hr	Max BTU/hr
TL50024	247	308
TL100024	493	602
TL150024	740	882

Table 2

Heat Dissipation (48V Power Modules)		
Model	Typical BTU/hr	Max BTU/hr
TL50048	180	281
TL100048	361	563
TL150048	541	844
TL200048	722	1100
TL250048	902	1355

Table 3

2.2 AC Input Requirement

2.2.1 AC input circuit breaker sizing

Table 4 shows the required input voltages for the available power modules. The power modules under wide line (WL) can be connected to a nominal input voltage between 100V & 240V. The power modules under high line (HL) can be connected to a nominal input voltage between 200V & 240V.

Power Module Input Voltages	
Wide Line (100V - 240V)	High Line (200V - 240V)
TL50048	TL150048
TL50024	TL150024
TL50012	TL200048
TL75012	TL250048
TL100048	
TL100024	

Table 4

2.2.2 AC Input Types

This system utilizes a single, dual, or individual feed AC architecture as shown in Figure 1, Figure 2, & Figure 3 via a rear AC terminal block.

The AC architecture can be determined from the model number of the rack. The model number of the rack can be found on the right side, near the rear of the rack.

2.2.2.1 Single Feed

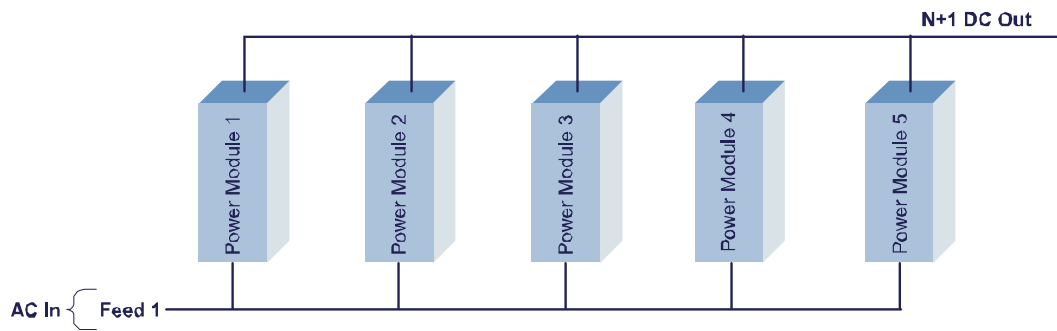

Figure 1 - Single Feed AC Wiring Architecture

2.2.3 AC current and cable sizing

A single feed architecture powers all five power modules with a single AC feed. Connect the feed, sized according to section 2.2.3, onto single #8-32 screws, and the ground will be connected to double, 1/4"-20 studs as seen in Figure 7. Choose AC ring terminals from section 2.2.4. The AC terminal strip on the rear of the rack will accept ring terminals of less than 0.5" wide. Two, 3/4" knockouts are provided for cable entry to the AC block.

2.2.2.2 Dual Feed

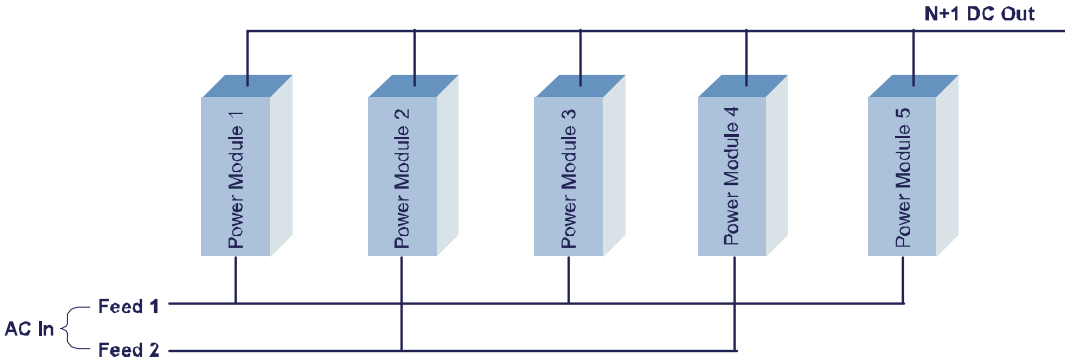

Figure 2 -Dual Feed AC Wiring Architecture

A dual feed architecture powers power module modules 1, 3, and 5 on AC feed 1, and modules 2 and 4 on AC feed 2. Connect the feed, sized according to section 2.2.3, onto single #8-32 screws, and the ground will be onto 1/4"-20 studs as seen in Figure 8. Choose AC ring terminals from section 2.2.4. The AC terminal strip on the rear of the rack will accept ring terminals of less than 0.5" wide. Two, 3/4" knockouts are provided for cable entry to the AC block.

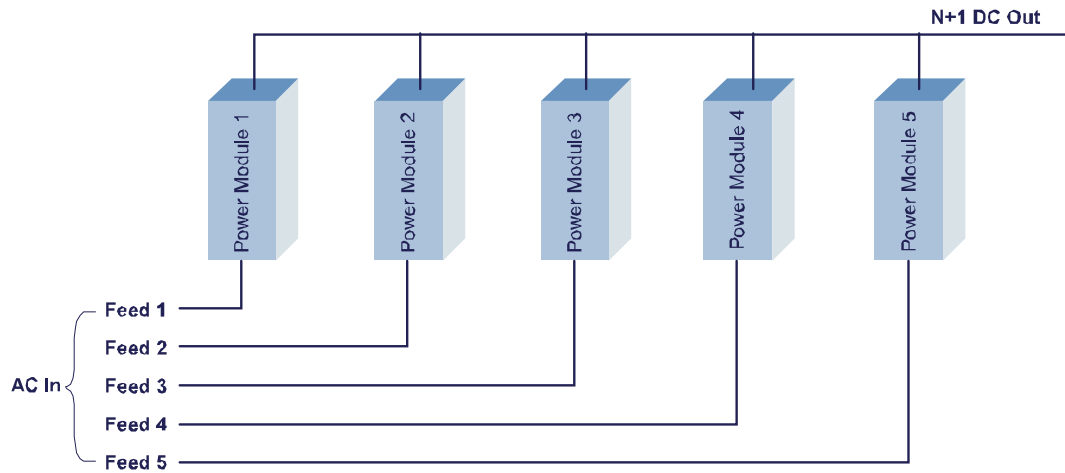

Figure 3 - Individual Feed AC Wiring Architecture

An individual feed architecture powers one power module slot per AC feed. Connect the feed, sized according to section 2.2.3, into IEC320 plugs as seen in Figure 9. There are two different types of individual AC feeds. The first type of AC connection is made with IEC320 connectors that are rated for a maximum of 15 amps. **Do not connect this type of individual AC system to an AC breaker larger than 15 amps.** The second type of AC connection is made with IEC320 connectors that are rated for a maximum of 20 amps. **Do not connect this type of individual AC system to an AC breaker larger than 20 amps.** See section 2.2.2 for help determining your AC architecture type.

2.3.3 Sizing AC feeds

To size your AC feeds properly, use Table 5, Table 6, and Table 7. Failure to size the AC breaker and wiring properly can result in nuisance breaker trips or even damage to the equipment. Follow the example below for determining AC breaker and wire sizing. Use section 2.2.2 to determine the AC input type, for example a dual feed. Next determine the number and model number of the power modules. Use Table 4 to determine the required AC input voltage.

The tables in this section use the absolute minimum input voltage at which the power modules will run at to determine AC requirements. 90 V corresponds to low line and 180 V corresponds to high line.

Recommended AC Circuit Breaker & Wire Sizes (12V system)						
Fully Equipped Rack	# of Power Modules on AC Feed	Minimum Input Voltage	Model # of Power Module	Maximum rated AC Current (Amps)	Circuit Breaker Minimum Value to use (Amps)	90°C Minimum Wire Gauge to use at 30°C ambient (AWG)
Individual AC feed	1	90	TL50012	6.7	15	14
		180	TL50012	3.5	15	14
		90	TL75012	10.0	15	14
		180	TL75012	5.2	15	14
	2	90	TL50012	13.5	15	14
		180	TL50012	6.9	15	14
		90	TL75012	20.0	20	12
		180	TL75012	10.4	15	14
Dual AC feed	3	90	TL50012	20.2	30	10
		180	TL50012	10.4	15	14
		90	TL75012	30.0	30	10
		180	TL75012	15.6	20	12
	4	90	TL50012	26.9	30	10
		180	TL50012	13.9	15	14
		90	TL75012	40.0	50	8
		180	TL75012	20.8	30	10
Single AC feed	5	90	TL50012	33.7	50	8
		180	TL50012	17.3	20	12
		90	TL75012	50.0	50	8
		180	TL75012	26.0	30	10

Table 5

Recommended AC Circuit Breaker & Wire Sizes (24V system)						
Fully Equipped Rack	# of Power Modules on AC Feed	Minimum Input Voltage	Model # of Power Module	Maximum rated AC Current (Amps)	Circuit Breaker Minimum Value to use (Amps)	90°C Minimum Wire Gauge to use at 30°C ambient (AWG)
Individual AC feed	1	90	TL50024	7.6	15	14
		180	TL50024	3.8	15	14
		90	TL100024	14.6	15	14
		180	TL100024	7.3	15	14
		180	TL150024	11.2	15	14
	2	90	TL50024	15	15	14
		180	TL50024	7.5	15	14
		90	TL100024	29.2	30	10
		180	TL100024	14.6	20	12
		180	TL150024	22.3	30	10
Dual AC feed	3	90	TL50024	22.7	30	10
		180	TL50024	11.3	15	14
		90	TL100024	43.8	50	8
		180	TL100024	21.9	30	10
		180	TL150024	33.5	50	8
	4	90	TL50024	30.2	30	10
		180	TL50024	15.0	15	14
		90	TL100024	58.4	75	6
		180	TL100024	29.1	30	10
		180	TL150024	44.7	50	8
Single AC feed	5	90	TL50024	37.8	50	8
		180	TL50024	18.8	20	12
		90	TL100024	73.0	75	6
		180	TL100024	36.4	50	8
		180	TL150024	55.9	75	6

Table 6

Recommended AC Circuit Breaker & Wire Sizes (48V system)						
Fully Equipped Rack	# of Power Modules on AC Feed	Minimum Input Voltage	Model # of Power Module	Maximum rated AC Current (Amps)	Circuit Breaker Minimum Value to use (Amps)	90°C Minimum Wire Gauge to use at 30°C ambient (AWG)
Individual AC feed	1	90	TL50048	7.4	15	14
		180	TL50048	3.7	15	14
		90	TL100048	14.6	15	14
		180	TL100048	7.3	15	14
		180	TL150048	10.9	15	14
		180	TL200048	14.6	15	14
		180	TL250048	18.2	20	12
	2	90	TL50048	14.8	15	14
		180	TL50048	7.4	15	14
		90	TL100048	29.2	30	10
		180	TL100048	14.6	15	14
		180	TL150048	21.9	30	10
		180	TL200048	29.1	30	10
		180	TL250048	36.4	50	8
Dual AC feed	3	90	TL50048	22.1	30	10
		180	TL50048	11.0	15	14
		90	TL100048	43.8	50	8
		180	TL100048	21.9	30	10
		180	TL150048	32.8	50	8
		180	TL200048	43.7	50	8
		180	TL250048	54.6	75	6
	4	90	TL50048	29.5	30	10
		180	TL50048	14.7	15	14
		90	TL100048	58.4	75	6
		180	TL100048	29.1	30	10
		180	TL150048	43.7	50	8
		180	TL200048	58.3	75	6
		180	TL250048	72.8	75	6
Single AC feed	5	90	TL50048	36.9	50	8
		180	TL50048	18.4	20	12
		90	TL100048	73.0	75	6
		180	TL100048	36.4	50	8
		180	TL150048	54.6	75	6
		180	TL200048	72.8	75	6
		180	TL250048	89.1	90	4

Table 7

2.2.4 AC lugs

Table 8 lists part numbers for some lugs you can use to attach your AC wire to the single and dual AC terminal blocks and ground studs. Use the #8 hole lugs for AC terminal block connections and single, 1/4"-20 hole lugs for ground connections.

Lug Part Number for AC Output				
AC Service Size	Wire AWG	Burndy Lug Part #	Amp Ring Terminal Part #	Description
15 AMPS	14 AWG		321045	For ground connection
15 AMPS	14 AWG		320565	For line connections
20 AMPS	12 AWG		323763	For line connections
20 AMPS	12 AWG		35605	For line connections
30 AMPS	10 AWG		323763	For ground connection
30 AMPS	10 AWG		35605	For line connections
50 AMPS	8 AWG	YA8CL1-BOX		For ground connection
50 AMPS	8 AWG	YA8CLNT6		For line connections
75 AMPS	6 AWG	YA6CL-BOX		For ground connection
75 AMPS	6 AWG	YA6CLNT6		For line connections

Table 8

2.3 DC Circuit Drawings

2.3.1 DC circuit 1

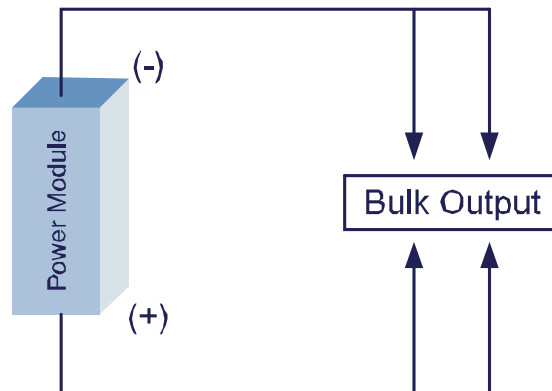

Figure 4 - DC Wiring Diagram

Each system is equipped with 2 unprotected bulk output connections as shown in Figure 4. Unprotected bulk connections are made with double hole lugs on ¼"-20 studs with 5/8" centers. The maximum tongue width for bulk connections is a lug at 0.68". Select a wire size for the bulk outputs according to the current rating as shown in Table 9. Choose lugs and ring terminals according to section 2.4.2.

2.3.2 DC reference ground

The Lambda Power system is a fully floating system. This means that the output bus bars are not tied to the chassis or an earth ground. An external reference or earth ground may be connected to either output bus bar based on the desired polarity of your system. The connection is double ¼"-20 studs with 5/8" centers. As always follow your company's guidelines for sizing and attaching a reference ground.

2.4 DC output wire sizing

There are two main considerations for sizing DC wire; ampacity and voltage drop. Ampacity refers to a safe current carrying level as specified by non-profit organizations such as Underwriters Laboratories and the National Fire Prevention Association, which publishes the National Electric Code. Voltage drop is simply the amount of voltage loss in a length of wire due to ohmic resistance of the conductor. DC wire may be sized for either ampacity or voltage drop depending on branch load loop length and conductor heating. In general, ampacity considerations will drive wire selection for short loop lengths (less than 50 feet) and voltage drop will drive wire selection for long loop lengths (greater than 50 feet). The National Electric Code table 310.16 provides ampacity values for various sizes, bundles, and insulation temperature rated wire. **ALWAYS FOLLOW NEC RULES AND YOUR LOCAL COMPANY PRACTICES WHEN SELECTING DC WIRING AND PROTECTION.** Table 9 shows **MAXIMUM** recommended wire sizes.

2.4.1 DC cable sizing

Unprotected DC output wires shall be based on the total power module capacity of the rack. For example, using Table 9 below, a system with four TL250048 (48V, 50A) power modules for a total capacity of 200 A requires two #2 AWG wires.

Minimum Recommended DC AWG for 90°C Cabling for Protected Outputs	
Total Power Module Current Rating (A)	Wire & Lug Gauge (AWG) using 90°C wire (NEC Table 310.16)
5	18*
10	16*
15	16
20	14
30	12
40	10
50	8
75	6
100	2
125	2
150	(1) 1 AEG or (2) 6 AWG
175	(2) 4 AWG
200	(2) 2 AWG
225	(2) 2 AWG
250	(2) 2 AWG
300	(2) 1 AWG

* For wire sizes less than 15 A not covered in NEC Table 310.16 use Table 3B - Sizes of Conductors, UL60950, "Safety of Information Technology Equipment", Dec., 2000 for non-building wiring.

Table 9

2.4.2 DC lugs

Table 10 lists part numbers for some lugs you can use to attach your DC wires to the system. These lugs are based on flex style cable.

Lug Part Number for DC Output			
Wire AWG	Burndy Lug Part #	Amp Ring Terminal Part #	Description
16 AWG		321045	SH Ring Terminal 1/4 Stud
14 AWG		321045	SH Ring Terminal 1/4 Stud
12 AWG		323763	SH Ring Terminal 1/4 Stud
10 AWG		323763	SH Ring Terminal 1/4 Stud
10 AWG	YAV102TC14		DH Lug Standard Barrel 1/4 Stud, 5/8 Center
8 AWG	YA8CL2TC14		DH Lug Standard Barrel 1/4 Stud, 5/8 Center
6 AWG	YAV6CL2TC14FX		DH Lug Standard Barrel 1/4 Stud, 5/8 Center
4 AWG	YAV2CL2TC14FX		DH Lug Standard Barrel 1/4 Stud, 5/8 Center
2 AWG	YAV2CL2TC14FX		DH Lug Standard Barrel 1/4 Stud, 5/8 Center
1 AWG	YAV1CL2TC14FX		DH Lug Standard Barrel 1/4 Stud, 5/8 Center

Table 10

2.5 Torque settings

Table 11 shows the recommended torque settings for all mechanical and electrical connections according to screw or nut size. Not all screw sizes may be present on a particular shelf.

Recommended Torque Settings	
Screw or Nut Size	Torque (in-lbs)
4-40	6
6-32	12
8-32	22
10-32	37
12-24	50
¼-20	65

Table 11

3 Required Tools

The power modules are designed to be installed with a minimum number of commonly available tools.

- #1 & #2 Phillips screwdrivers
- Torque wrench
- 5/16" or 7/16" box wrenches, sockets, or nut drivers
- Wire and Cable Strippers
- Wire and Cable Crimpers

4 Site and Equipment Preparation

After removing DC Power Plant from boxes and packing material, inspect for shipping and/or other damage. Have all tools, wire, cables, hardware, etc., within easy reach. To the extent possible ensure a clean (free of debris, dust, foreign material, etc.) work environment. Ensure all AC and DC power sources are off and disconnected.

5 Power Plant Mounting and Wiring

5.1 Mechanical mounting

This equipment is intended for normal operations and is to be installed in a standard 19" enclosure. It is recommended that one person lift the rack into place while another installs supplied mounting hardware. Torque mounting hardware according to Table 11. A gap of a minimum of $\frac{3}{4}$ inch above and below the system is required for proper airflow. We recommend that you use at least two screws per bracket.

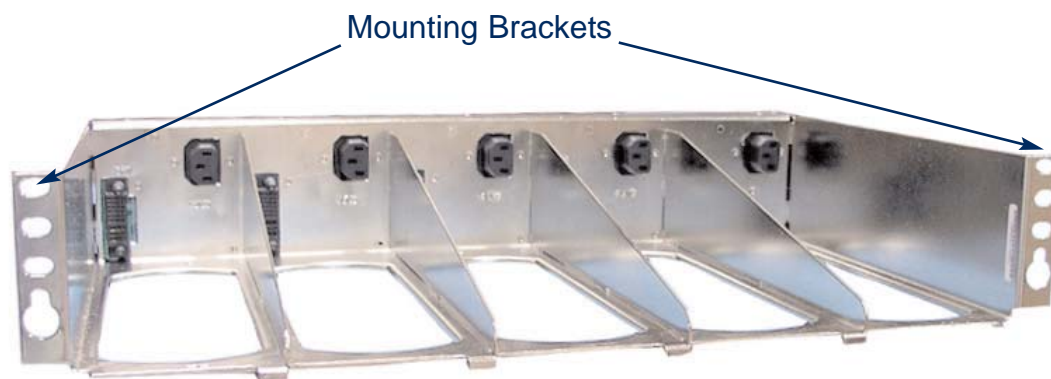

Figure 5 - Front View

5.2 AC input

For systems using AC power cords, knockouts are provided to route AC cables to the proper connections on the single and dual feed shelves. Remove the cutout and place the provided cord grip in the knockout to provide protection and security to the AC cord. Otherwise use conduit to run your AC wires to the system.

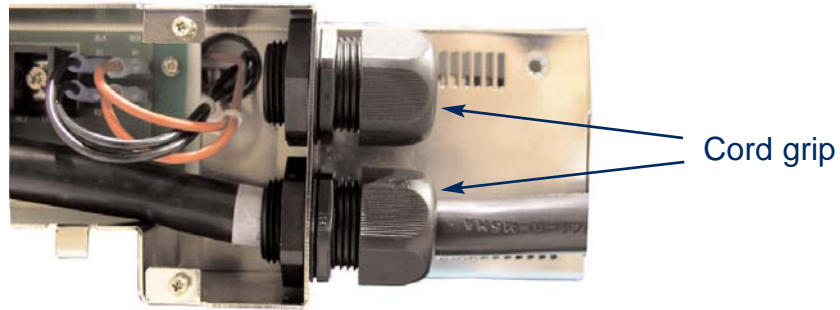

Figure 6 - AC cord grip

5.2.1 Single Feed

For 110 VAC service, connect your line/hot to Line 1, labeled on the AC terminal block shown in Figure 7. Connect your neutral to the slot labeled Line 1/N1. These connections are made with ring terminals on a #8-32 screws, and torque according to Table 11. The ground is connected the 1/4"-20 studs labeled "AC ground", and torque according to Table 11.

For 208/220 VAC service, connect your line/hot to Line 1, labeled on the AC terminal block shown in Figure 7. Connect your second line/hot to the slot labeled Line 1/N1. These connections are made with ring terminals on a #8-32 screws, and torque according to Table 11. The ground is connected the 1/4" stud labeled "AC ground", and torque according to Table 11.

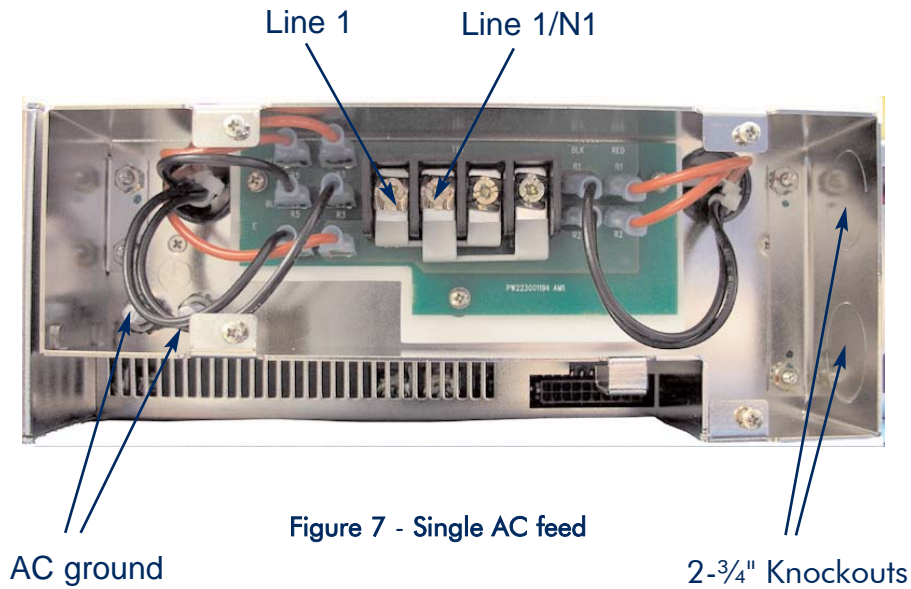

Figure 7 - Single AC feed

When ready to power up, plug in the AC cord into the proper receptacle or turn on the AC breaker.

5.2.2 Dual Feed

For 110 VAC service, connect your first line/hot to Line 1, labeled on the AC terminal block shown in Figure 8. Connect your neutral to the slot labeled Line 1/N1. For your second feed connect line/hot to the slot labeled Line 2. Connect your neutral to the slot labeled Line 2/N2. These connections are made with ring terminals on a #8-32 screws, and torque according to Table 11. Connect both grounds to the ¼" studs labeled "AC ground", and torque according to Table 11.

For 208/220 VAC service, connect your first line/hot to Line 1, labeled on the AC terminal block shown in Figure 8. Connect your second line/hot to the slot labeled Line 1/N1. For your second feed connect line/hot to the slot labeled Line 2. Connect your second line/hot to the slot labeled Line 2/N2. These connections are made with ring terminals on a #8-32 screws, and torque according to Table 11. Connect both grounds to the ¼" studs labeled "AC ground", and torque according to Table 11.

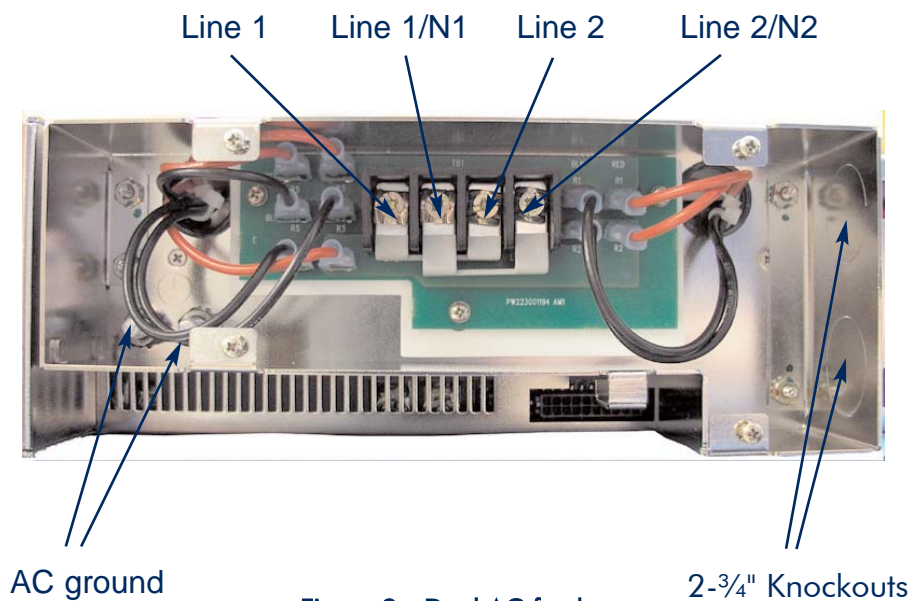

Figure 8 - Dual AC feed

When ready to power up, plug in the AC cord into the proper receptacle or turn on the AC breaker.

5.2.3 Individual Feed

For any AC service between 100 VAC to 240 VAC connect each line cord into the appropriate AC receptacle on the rear on the rack as seen in Figure 9.

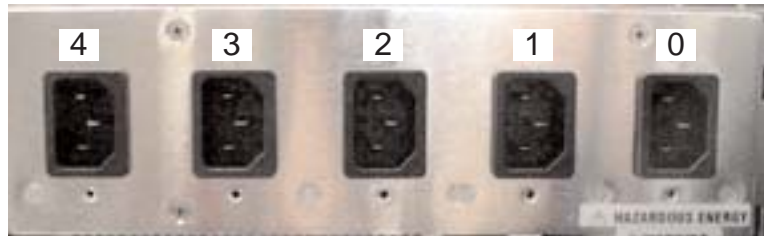

Figure 9 - Individual AC feed (15 amp plugs shown)

When ready to power up, plug in the AC cord into the proper receptacle or turn on the AC breaker.

5.3 DC output

DC connections are accomplished via the two rear bulk output connections as shown in Figure 10. Connections are made with double hole lugs with $\frac{1}{4}$ "-20 studs with $\frac{5}{8}$ " centers. Select wire and lug sizes according to Section 2.3.

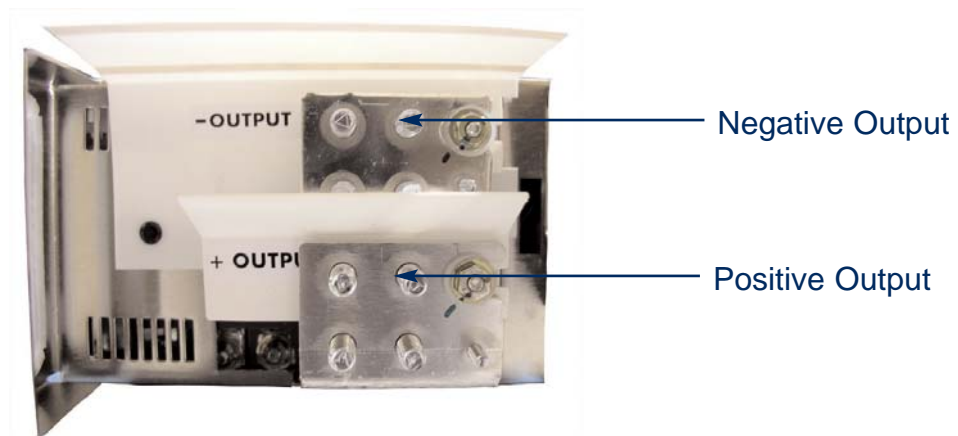

Figure 10 - DC Connections

Route DC cables out the side of the rack through the cable routing holes seen in Figure 11.

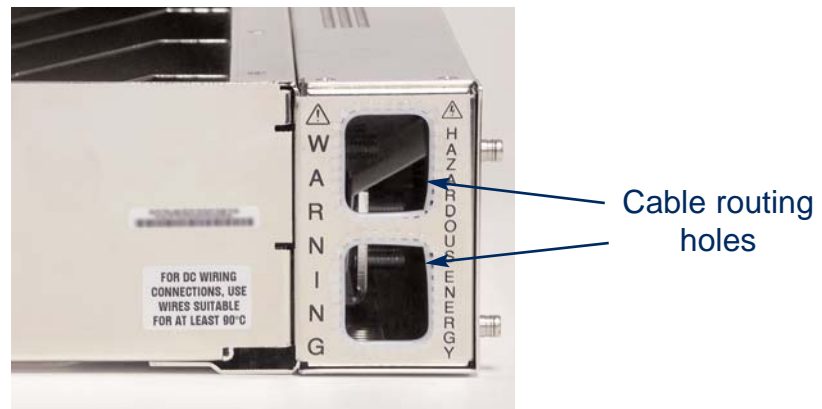

Figure 11 - Cable routing holes

5.4 DC Reference ground

Connect your reference ground to either the negative output or positive output (Figure 10) depending on the desired polarity. The connection is double $\frac{1}{4}$ "-20 studs with $\frac{5}{8}$ " centers.

5.5 Alarms and control

Access to alarms and control signals is accomplished via a rear mounted connector (p/n 43045-2019, Molex) as shown in Figure 12. Table 12 provides a pin functional description.

- The pin out of the alarm connector on the rack is a 180° difference from a standard Molex connector. See Figure 11 & Figure 12.
- AC fail, DC fail, and Thermal limit fail alarms are all open collector, opto-coupled, active high on failure/active low normally (software or factory configurable), and referenced to pin 17. The pin is able to sink 10 mA of current at 5 V and 5 mA at TTL voltages.
- Applying 5 V between pins 16 and 17 will shut all power modules down. Removing the 5V will cause the rectifier to power back up.

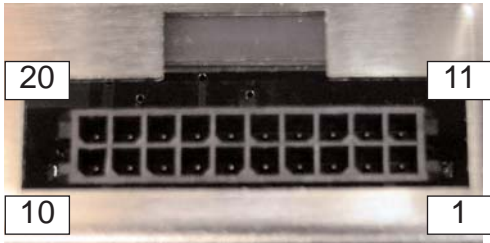

Figure 12 - Alarm and signal connector on shelf

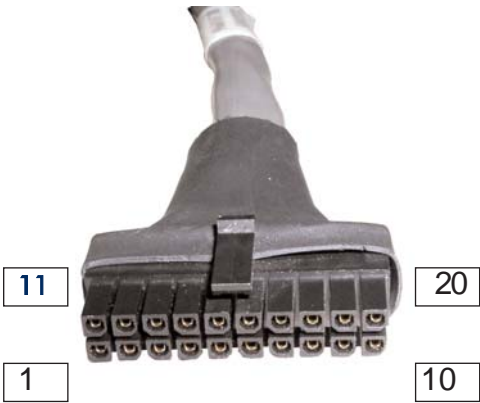

Figure 13 - Alarm cable pin out

Alarm and Signal Interconnections		
J1 Pin	Wire Color	Description
20	BLK	Shelf Bias: A regulated 12V/100ma bias supply. Referenced to Pin 10.
19	RED	SCL: I ² C clock line. Referenced to Pin 10.
18	RED/WHT	SCL: I ² C clock line. Referenced to Pin 10.
17	RED/BLK	Logic Ground: Isolated ground for opto-coupled alarms.
16	GRN/WHT	Module Disable: Opto-coupled input. Applying 5V between this pin and Pin 17 will disable all modules in the rack.
15	LT BL	Module 1 (leftmost slot) AC Fail.
14	LT BL/WHT	Module 2 AC Fail
13	LT BL/BLK	Module 3 AC Fail
12	YLW/WHT	Module 4 AC Fail
11	YLW/BLK	Module 5 (rightmost slot) AC Fail
10	TAN/WHT	V Main Output (-). DC power ground.
9	TAN/BLK	I Shelf: Indicates average rack current. Ratio varies with power module type. Call factory for details.
8	TAN	V Margin: Applying a 0-5V signal from this pin to Pin 10 will linearly change the output voltage by 0-10V.
7	GRN/BLK	Not used
6	GRN	Module Thermal Limit Failure
5	OR/WHT	Module 1 (leftmost slot) DC Fail
4	OR/BLK	Module 2 DC Fail
3	OR	Module 3 DC Fail
2	WHT	Module 4 DC Fail
1	YLW	Module 5 (rightmost slot) DC Fail

Figure 12 - Alarm and Signal Interconnections

6 Test and Turn-Up

6.1 Power up

Once all AC and DC connections have been secured and checked, install each power module sequentially by sliding and latching each power module into a rack position as shown in Figure 14. The power module latches must be open for installation. Attempting to install the power modules with the latches closed will result in mechanical damage to the power modules and the rack. The power modules will start in high fan speed mode and reduce their speed according to the ambient and plant conditions within 10 seconds. The AC OK and DC OK LED's will illuminate and the ALM LED will extinguish.



Figure 14 - Power Module Insertion

7 Troubleshooting

7.1 Problems and Solutions

The modular, plug-n-play nature of this plant makes diagnostics and repair very easy. Make sure that all power modules are properly seated and latched into their respective slots. Make sure that all power and signal connectors are properly mated. Table 13 lists problems and potential solutions.

Problems and Solutions	
Problem	Solution
DC OK LED extinguished or Module DC fail via alarm cable	Replace bad power module unit - unlatch, remove and replace with spare. System short circuit - inspect and replace load and wiring.
AC OK LED Extinguished or Module AC fail via alarm cable	Reset commercial circuit breaker to the dedicated AC circuit that feeds system. Seek alternative power source until power is restored.
Thermal Limit Failure	Power module has shut down because it has exceeded the maximum rated temperature. The power modules will automatically restart.

Table 13 - Problems and Solutions

7.2 Short circuit & Current Limit

I_{Limit} can be adjusted up to +105% of the rated current of the power module. The system voltage will remain constant up to I_{Limit} at which point the system voltage will drop quickly toward 0 VDC, as in Figure 15. Once a 24V or 48V power module drops below 12 VDC for more than 5 seconds, the system will shut down. For a 12V system, once the power module drops below 4V for more than 60 seconds, the system will shut down. The system will automatically restart after 60 seconds, and will continue until the short circuit is cleared.

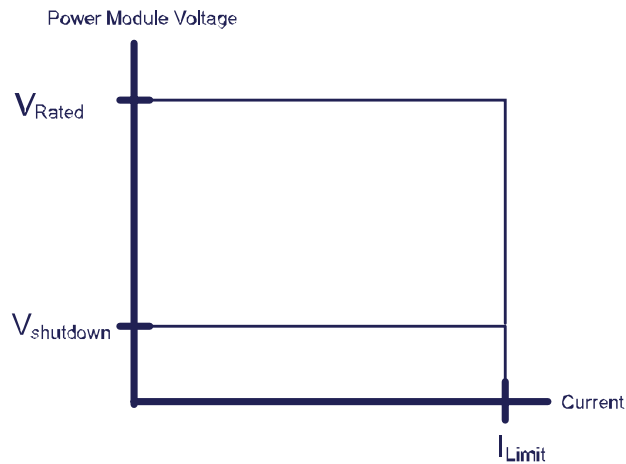

Figure 15 - Short Circuit & Current Limit

8 Installationsanleitung (German Installation)

Eingangsspannung (Voltage):

Eingangsspannung (Voltage)	
Netzteile fuer (100V - 240V)	Netzteile fuer (200V - 240)
TL50048	TL150048
TL50024	TL150024
TL50012	TL200048
TL50012	TL250048
TL75048	
TL100024	

Table 1

Eingangsstrom (Current): 75A
 Nennfrequenz (Frequency): 50/60Hz
 Modellnummer (Modell No.) : TLXXXX

Abmessungen sind nur zur Referenz (Dimensions are for reference only):

- Depth: 14"/ 35.6cm
- Height: 3.45"/ 87.6cm
- Width: 17.5" (std. 19")/ 44.5cm

Max. Umgebungstemperatur :TL200048 power module, full power: 65C/Vollast (Max Operation temperatur) TL150024, N+1 configuration: 70C

Ausgangsspannungen und -strome 54V, max 250A (Output Voltage and Current)

- Das Gerät darf nur in Räumen mit beschränktem Zutritt aufgestellt werden.
- (Nur ausgebildetes Personal) Restricted Access Locations only.
- Das Gerät muß mindestens mit einer Anschlußleitung 4 x mm oder 5 x mm versehen sein. (Minimum wire sizes)
- Das Gerät hat keinen eigenen Ausschalter, es muß daher mit einem Ein- und Ausschalter im Versorgungskreis versehen sein. No mains ON/OFF switch is provided; disconnection means must be provided in the end-installation.
- Das Gerät hat kein Brandschutzgehäuse es darf daher nur auf nicht brennbaren Untergrund aufgestellt werden. (Beton, Metall usw.) Unit must be installed over non-combustible flooring
- Beim Aufstellen des Gerätes ist darauf zu achten das alle Anforderungen gemäß EN60950 eingehalten werden. Installation must comply with EN60950.