

General Description

The MAX98090 (TQFN) evaluation kit (EV kit) is a fully assembled and tested circuit board that evaluates the MAX98090 (TQFN) audio codec. The MAX98090 is an integrated audio codec including an earpiece amplifier, stereo Class D amplifier, stereo DirectDrive® headphone amplifier, and digital signal processing.

To enable easy connection to a wide range of audio sources, the EV kit includes audio devices to convert both USB and S/PDIF data to I²S data. The EV kit also integrates a MAXQ2000 microcontroller to enable I²C and SPI communication with the on-board I²C- and SPI-capable devices. A simple and intuitive graphical user interface (GUI) provides communication with the EV kit through Windows® OS running Windows XP®, Windows 7-, or Windows 8-compatible software.

Features

- Fully Assembled and Tested
- 2.8V to 5.5V Single-Supply Operation
- Proven Audio PCB Layout
- On-Board USB-to-I²C Interface
- On-Board USB-to-I²S Converter
- On-Board S/PDIF Transceiver
- On-Board Clock Source
- On-Board Digital Microphone
- Windows XP-, 7-, and 8-Compatible Software

EV Kit Contents

- MAX98090 TQFN Evaluation Kit
- Two A-to-B Mini-USB Cables

Ordering Information appears at end of data sheet.

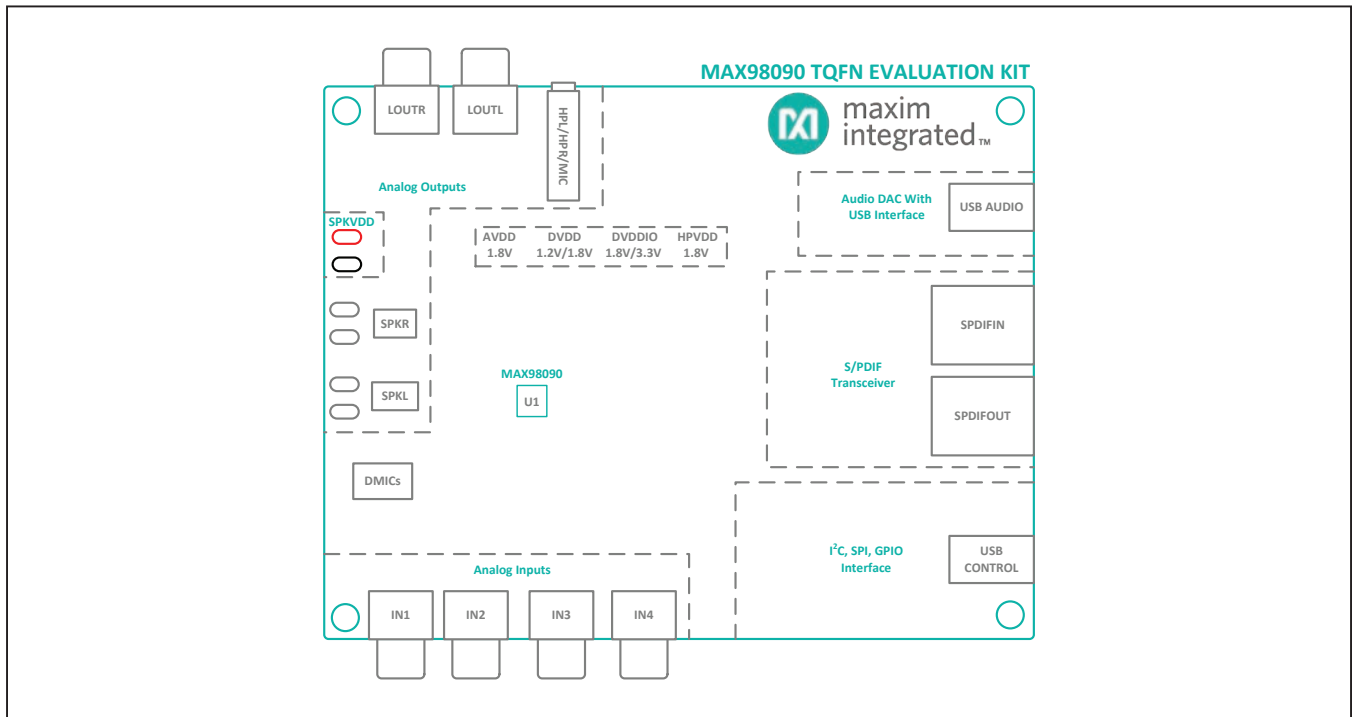

Figure 1. Simplified EV Kit Block Diagram

DirectDrive is a registered trademark and service mark of Maxim Integrated Products, Inc.

Windows and Windows XP are registered trademarks and registered service marks of Microsoft Corp.



Quick Start

Required Equipment

- MAX98090 EV kit (TQFN)
- Two A to mini-B USB cables (included)
- 2.8V to 5.5V, 2A DC power supply
- Set of headphones with a 3.5mm plug
- User-supplied Windows XP, Windows 7, or Windows 8 PC with two available USB ports

Note: In the following sections, software-related items are identified by bolding. Text in **bold** refers to items directly from the EV kit software. Text in **bold and underlined** refers to items from the Windows operating system.

Procedure

Follow the steps below to configure the EV kit for audio playback and control, from a PC, to verify the EV kit's functionality.

- 1) Visit www.maximintegrated.com/evkitsoftware to download the latest version of the MAX98090 software, **98090Rxx.ZIP**. Save the software to a temporary folder and uncompress the ZIP file.
- 2) Install the software and USB driver on your computer by running the INSTALL.EXE program inside the temporary folder. The program files are copied and icons are created in the Windows **Start | Programs | Maxim EVKIT Software** menu. During software installation some versions of Windows may show a message indicating that this software is from an unknown publisher. This is not an error condition and it is safe to proceed with the installation.
- 3) Verify that all jumpers are in their default positions, as shown in [Figure 2](#) (same as listed in [Table 2](#)).
- 4) Connect the power supply between the SPKVDD and GND PCB pads.
- 5) Set the power supply to 4.2V with a 2A current limit and turn it on.
- 6) Connect a USB cable between the PC and the J1 USB port (USB CONTROL) on the EV kit. A Windows message appears when connecting to the EV kit for the first time. Each version of Windows may have a slightly different message. If Windows reports that the device is ready to use, then the USB driver has been installed successfully.
- 7) If needed, the USB driver can be manually installed by navigating to the **C:\Program Files(x86)\Maxim\MAX98090** folder (default installation directory) and following the instructions in the **USB_Driver_Help_300.PDF** document.
- 8) Connect headphones to the headphone jack (HP).
- 9) Start the MAX98090 software by opening its icon in the **Start | Programs | Maxim EVKIT Software** menu. The software main window appears, as shown in [Figure 4](#).
- 10) Wait while the software connects to the EV kit. Once the connection is established, the status bar at the bottom will indicate that the USB and device are connected.
- 11) Once the USB and device connections have been established, select the **Block Diagram** tab.
- 12) Click on the **USB** block.
- 13) Click **Yes** to automatically configure the EV kit for USB audio playback.
- 14) Connect a USB cable between the PC and the J2 USB port (USB AUDIO). Windows automatically detects the EV kit as a sound card and installs the USB audio class drivers.
- 15) Open Windows' **Sound** dialog and select the **Playback** tab. A **USB Audio DAC** item, similar to [Figure 3](#), is added to the list of available playback devices. All audio played through this device is sent to the EV kit.
- 16) Verify that the **USB Audio DAC** item is set as the default device.
- 17) Verify that audio can be heard through the connected headphones.
- 18) Quick start complete. Refer to the MAX98090 IC data sheet for additional information.

MAX98090 Software Files

| FILE | DESCRIPTION |
|-------------------------|---|
| Install.exe | Install the MAX98090 software files on the computer |
| CDM21000.exe | USB driver installer |
| Device Manager | Shortcut to computer's device manager |
| USB_Driver_Help_300.pdf | USB driver installation help file |

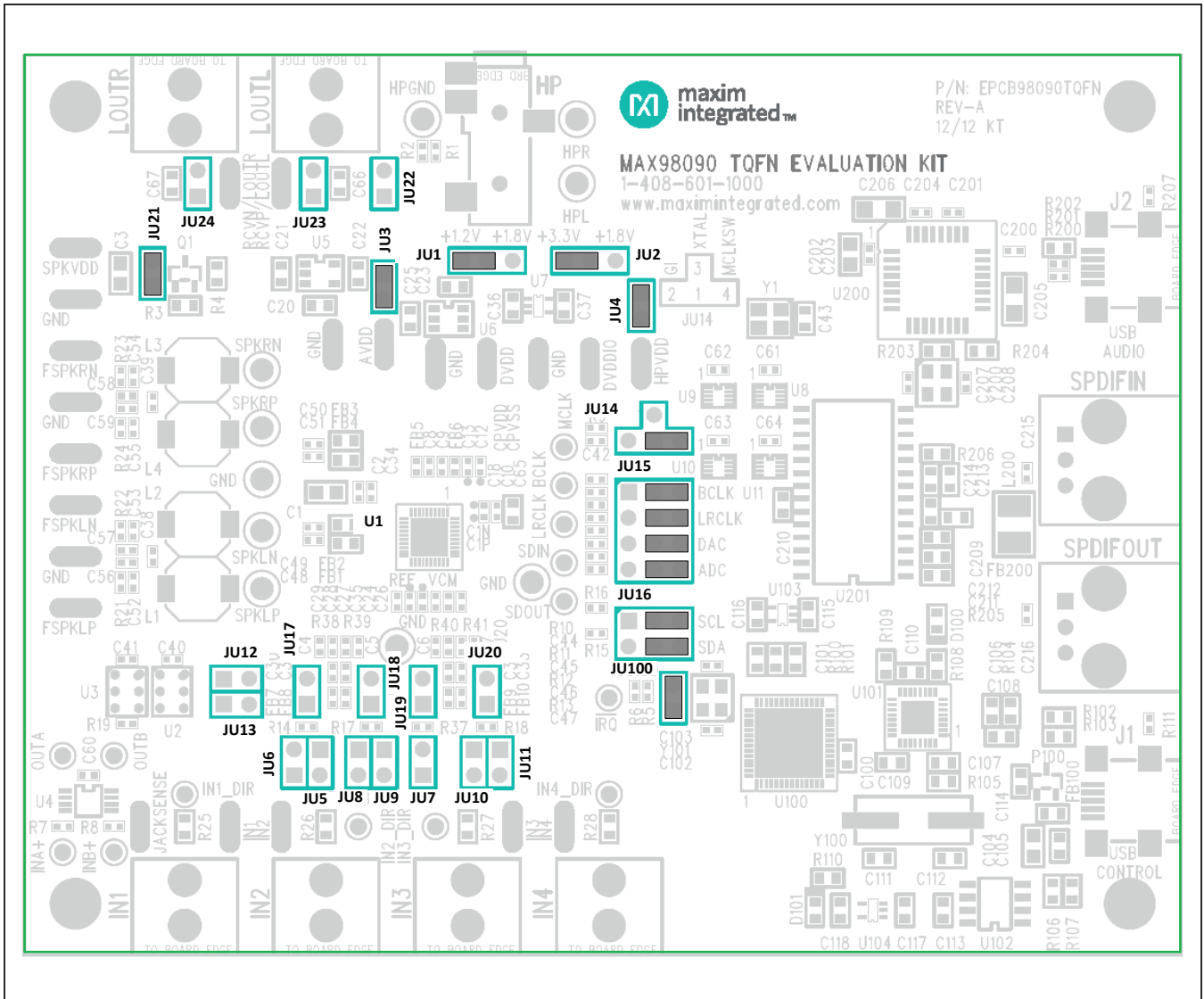

Figure 2. Default Shunt Configuration

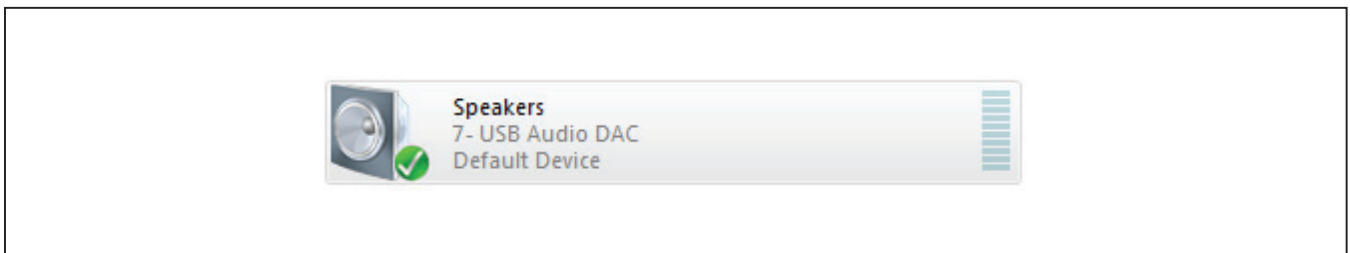

Figure 3. Playback Device

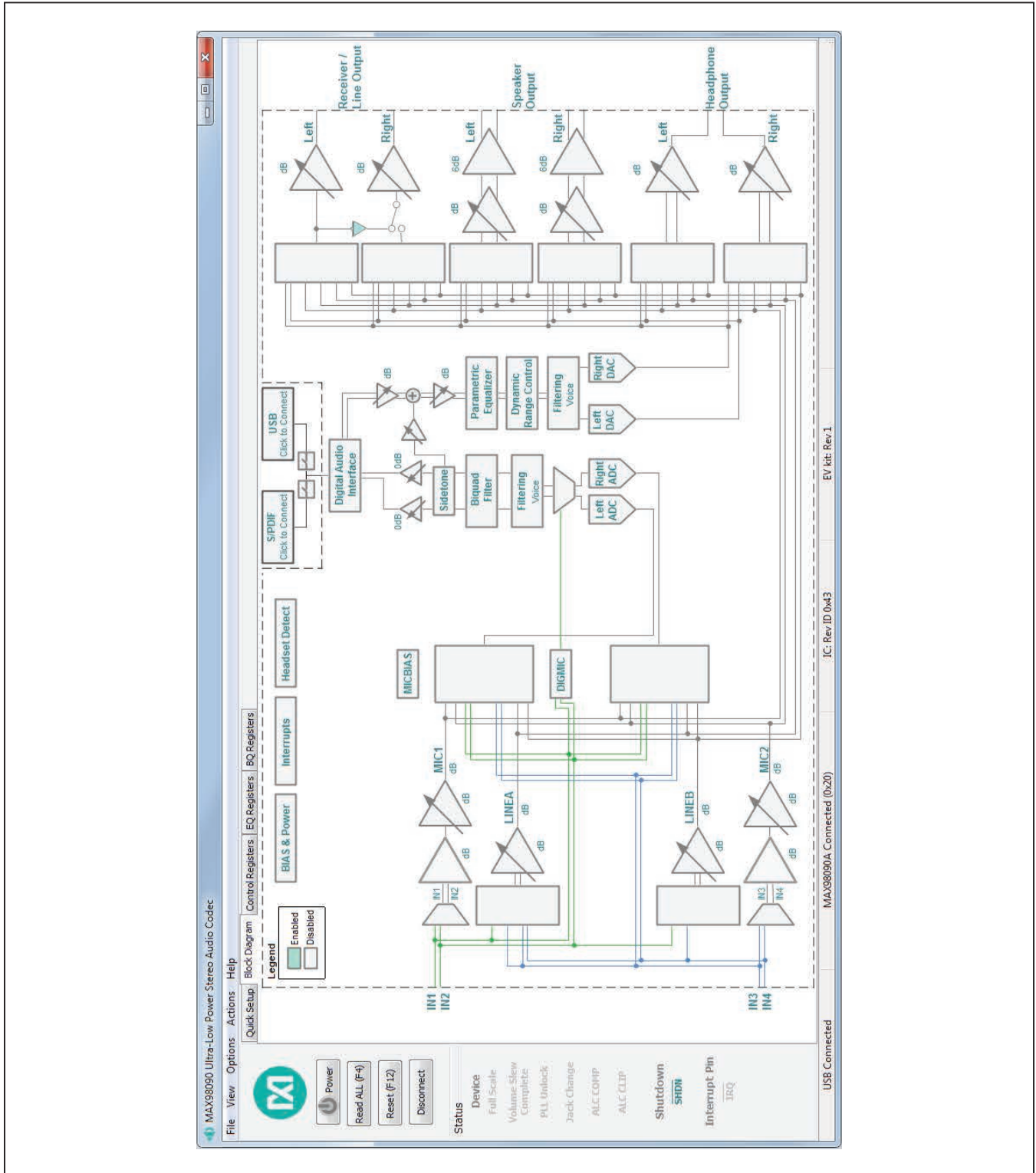

Figure 4. MAX98090 Software Main Window

Detailed Description of Software

The MAX98090 EV kit is intended to be evaluated with the MAX98090 software, as it provides an intuitive graphical user interface (GUI) for programming the MAX98090 device and also includes a handful of features that are intended to aid evaluation.

The MAX98090 software main window is divided into three sections: software buttons, status panel, and tabbed pages (Figure 4). The buttons provide basic functionality and the status panel provides monitoring capabilities. The tabbed pages provide the controls to program the MAX98090.

The **Quick Setup** tab provides access to the device's quick setup registers (0x04–0x0B). The **Block Diagram** tab provides access to all the device registers and uses diagram blocks to access dialog windows. The dialogs contain the GUI controls used to program the device. The **Control Registers** tab provides access to registers 0x00–0x45 as well as to the revision ID register, 0xFF. The **EQ Registers** tab provides access to the device's parametric equalizer (EQ), registers 0x46–0xAE. The **BQ Registers** tab provides access to the device's biquad (BQ) filter, registers 0xAF–0xBD.

The MAX98090 software can be downloaded from www.maximintegrated.com/evkitsoftware. When evaluating with the MAX98090 EV kit and software, it is recommended that this document be used in conjunction with the MAX98090 IC data sheet.

Software Buttons

There are four buttons available on the main window of the MAX98090 software: **Power**, **Read ALL (F4)**, **Reset**

(F12), and **Connect**. These buttons are always accessible, regardless of the active tab.

Power

The **Power** button programs the MAX98090's $\overline{\text{SHDN}}$ bit to enable/disable the device. When the device is disabled/enabled, the button image is gray/blue, respectively. When the device is in shutdown (SHDN bit = 0) the software is still able to communicate with the device, as its I2C interface remains active.

Read ALL (F4)

The **Read ALL (F4)** button performs the following sequence of reads and updates the associated register tab. This function is also available from the **Actions** menu.

- Read the MAX98090 $\overline{\text{IRQ}}$ pin. This only updates the **Status** panel.
- Read the status register (0x01). This also updates the **Status** panel.
- Read control registers (0x03–0x45).
- Read parametric equalizer registers (only if the **EQ Registers** tab is visible **or** if EQ bands are enabled).
- Read biquad registers (only if the **BQ Registers** tab is visible **or** if the biquad filter is enabled).
- Read Revision ID register (0xFF).
- Read S/PDIF Transceiver (U201) registers.

Reset (F12)

The **Reset (F12)** button resets the checked items as indicated on the **Reset** dialog window (Figure 5). This function is also available from the **Actions** menu.

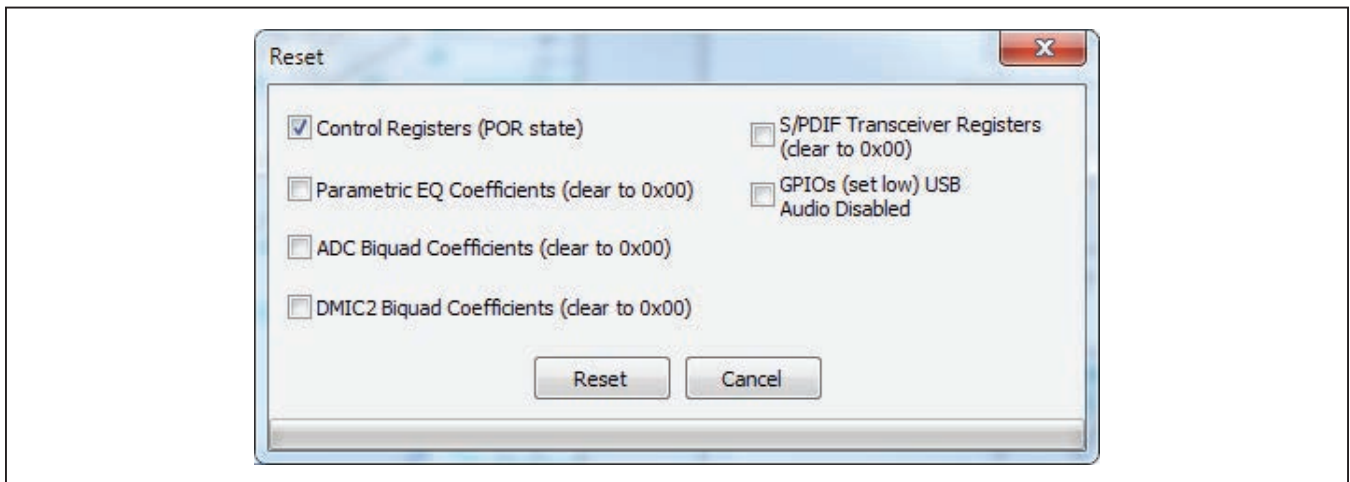

Figure 5. Reset Dialog Window

Connect/Disconnect

The **Connect/Disconnect** button is used to connect or disconnect from the MAX98090 EV kit, which is connected to the PC via its USB CONTROL (J1) port or a TCP connection. The button either displays **Connect** or **Disconnect**, depending on the current state of the EV kit connection.

When the button displays **Connect**, it indicates that the software is not connected to the EV kit. Pressing the button initiates the connection sequence. When using a TCP connection, ensure that it has been set up in the software before pressing **Connect**. The TCP connection is configured from the **TCP Configuration Setup** dialog, which is accessed by selecting **Options | Connect Options | TCP** from the **Menu** bar.

When the button displays **Disconnect**, it indicates that the software is connected to the EV kit. Pressing the button initiates the disconnect sequence.

Status Panel

The MAX98090 **Status** panel, located on the left side of the software main window, displays the state of the six status bits (register 0x01), the shutdown bit (register 0x45), and the state of the MAX98090 hardware **IRQ** pin. The color of a **Status** label indicates whether it is asserted or not asserted. When asserted, the label is teal colored; when not asserted, the label is light gray.

Note: A status bit's interrupt must be enabled in order for the status bit to get updated in the Status register. The interrupts are enabled from the **Interrupts** block.

Quick Setup Tab

The **Quick Setup** tab provides controls for configuring the quick setup registers (0x04–0x0B). These quick setup registers are write-only and operate like pushbuttons. Refer to the *Quick Setup Configuration* section of the MAX98090 IC data sheet for additional details.

As the first four steps are completed, the section at the bottom of **Step-5** will be updated. Checkmarks indicate that the step is complete and the **Reg:** and **Bit-** labels indicate which quick setup register and bit are programmed.

For simplicity, this tab is divided into five steps as shown in [Figure 6](#). The first three steps configure the **System Clock**, **Sample Rate**, **Mode**, and **Format**. The fourth step configures the audio **Input** and **Output** (I/O) signal path. As I/O selections are made, a corresponding image is shown in the **Configuration** group box, providing a visual representation of the selected path. When a valid I/O path is selected, **Step-4** is complete. To clear the input and output selections, press the **Clear** button.

Once all four checkmarks are visible, press the **Configure** button to program the device. If an invalid I/O path is selected, the software reports “**Not a valid I/O configuration**” and the I/O selections are cleared.

Block Diagram Tab

The MAX98090 software uses a block diagram to facilitate the programming of the MAX98090 as well as provide a visual representation of the device's functions and current configuration. The controls for a given function are grouped on the same dialog window, which is opened by clicking on the associated block image. The blocks that are within the dotted border are related to the MAX98090 device and the blocks outside the dotted border are for the associated support circuitry.

There are two types of blocks in the block diagram and they are distinguished by the mouse cursor image. The mouse cursor will change to a hand when over an active block and will change to an up-arrow when over a toggle block. An active block opens a dialog window, containing controls for configuring the MAX98090. A toggle block does not open a dialog window, but toggles a specific setting when clicked.

The color of the blocks changes, depending on the enabled state of the function(s) it controls. A disabled block is gray and an enabled block is teal. [Figure 7](#) shows the block diagram with the MAX98090 configured for USB audio input and headphone output. **Note:** A disabled/enabled block does not necessarily indicate that its associated audio path is disabled/enabled.

S/PDIF and USB

The **S/PDIF** and **USB** blocks are outside the dotted border and thus not related to the MAX98090 device. These blocks represent the stereo digital audio transceiver (U201) and the USB stereo audio DAC (U200) that are designed onto the EV kit. These blocks are used to enable the associated circuits, but also include controls that automatically configure the MAX98090 to work with the enabled audio device.

The S/PDIF and USB audio devices are connected to the MAX98090 I²S bus through analog switches (U9-U11), which are controlled through the MAX98090 software. These switches are automatically configured once the S/PDIF or USB block is enabled, but they can be toggled by clicking on the switch blocks.

The screenshot displays the 'Quick Start Tab' configuration interface for the MAX98090. The interface is organized into five sequential steps:

- Step-1:** System Clock configuration. Options include 255fs, 11.2896MHz, 12MHz, 12.288MHz (selected), 13MHz, 19.2MHz, and 26MHz.
- Step-2:** Sample Rate configuration. Options include 8kHz, 16kHz, 32kHz, 44.1kHz, 48kHz (selected), and 96kHz.
- Step-3:** Mode and Format configuration. Mode options are Master and Slave (selected). Format options are Right Justified and Left Justified (selected).
- Step-4:** Input and Output configuration. Input options include IM1-4 and MIC1-2. Output options include LINE/RCA, Speaker, Headphone, and DAI.
- Step-5:** Configuration summary. A block diagram shows the signal flow from Digital Audio through L and R channels to speakers or headphones. A progress indicator shows 'Step-1' through 'Step-4' completed, with 'Step-5' in progress. 'Configure' and 'Clear' buttons are present.

Figure 6. Quick Start Tab

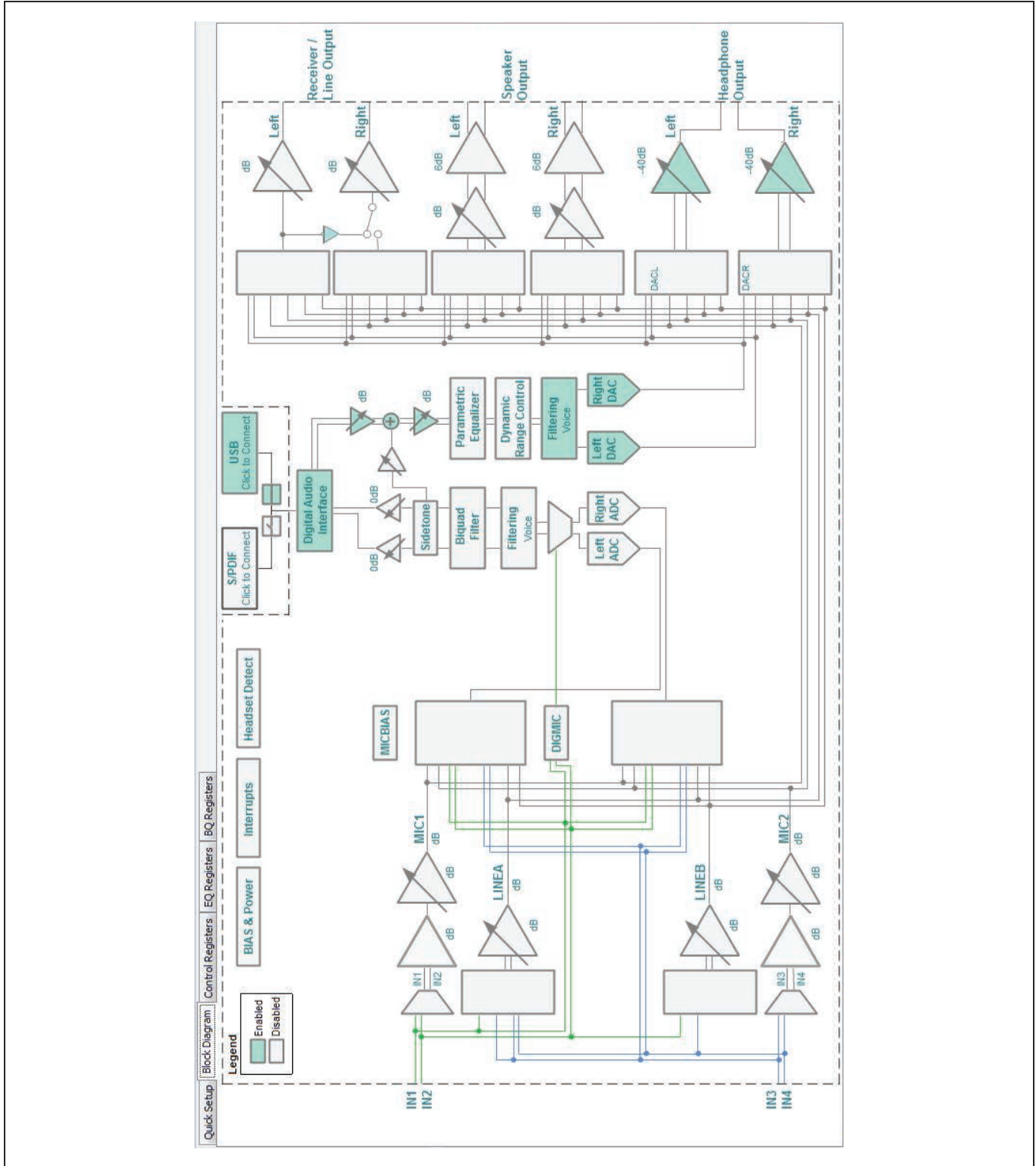

Figure 7. MAX98090 Software Block Diagram

Dialog Windows

Dialog windows are associated with specific blocks in the block diagram and they contain the controls for configuring the registers that are associated with that particular block of the MAX98090 IC. The highlighted blocks in [Figure 8](#) are the blocks that share a dialog window. In addition, the blocks that are outlined can have their dialog windows synchronized to each other. This dialog sync feature is a software feature and is enabled by selecting the **Sync Right and Left** checkbox on the dialog window. When enabled, the software programs the same user configurations to both the left and right output channels.

A dialog window is opened by clicking on a diagram block. [Figure 9](#) shows the typical GUI controls that are found on dialog windows and [Figure 10](#) shows the more advanced biquad filter dialog. When a control's state is changed, it results in the programming of the associated device register(s).

The biquad dialog uses the same types of controls as other dialogs, but it also provides a plot of the filter's amplitude and phase. This provides a visual representation of the programmed coefficients as well as some insight into the filter's behavior. The only two blocks that use this type of biquad filter dialog are the **Biquad Filter** and **Parametric Equalizer** blocks.

The filter dialog shown in [Figure 10](#) is for the 7-band parametric equalizer as can be seen by the 7 available filters. Each filter can be individually programmed and when selected will show up as yellow lines on the plots. A sum of all the enabled filters can be displayed by selecting the **Show Cascade** checkbox. The cascaded response will show up as blue lines on the plots. The **Biquad Filter** dialog window is similar to that shown in [Figure 10](#), except that it is only a single biquad filter.

Registers Tabs

The MAX98090 software has three device register tabs: **Control Registers**, **EQ Registers**, and **BQ Registers**. These register tabs display the device's registers in a typical register map format. Each of the register tabs provides two methods for configuring the device. For example, [Figure 11](#) shows the register tab elements of register 0x25.

The first configuration method involves clicking on the register's bit labels. A grayed-out bit label indicates that the bit is currently set low. A bold bit label indicates that the bit is currently set high. Clicking on a bit will toggle its state and result in a write to that register. This action also updates the value displayed in the register's **Edit**

box, located to the right of the bit labels. **Note:** Read-only bits cannot be clicked/toggled and are only meant to display the register's current state. These read-only bits are updated by performing a read all operation.

The second configuration method involves entering a hexadecimal value in the register's associated **Edit** box and then pressing the Enter key. The software will automatically configure the device register once the Enter key is pressed. This method will also update the state of the bit labels to reflect the value shown in the **Edit** box.

Control Registers

The **Control Registers** tab provides access to most of the device's control registers and all of its status registers. The range of registers accessible from this tab is from register address 0x00 through 0x45 and the revision ID register (0xFF).

The **Write All (F8)** button writes to all the writable registers on the **Control Registers** tab. It also writes to all the S/PDIF transceiver registers, and updates the configurable GPIOs

Register changes made through this tab are reflected on the **Block Diagram** tab. As such, the **Control Registers** tab and the **Block Diagram** tab are always in-sync. However, register changes made through the **Control Registers** tab are not automatically reflected on open dialog windows. To have an open dialog window updated, close then re-open the dialog window.

Equalizer (EQ) Registers

The main use of the **EQ Registers** tab is to provide access to the raw data contained in the EQ registers (0x46 through 0xAE). The preferred method for configuring the device's equalizer is through the **7-Band Parametric Equalizer** dialog window ([Figure 10](#)).

The registers on this tab are grouped into seven bands (Band 1 through Band 7) and each band consists of fifteen registers. These fifteen registers are then divided into five coefficients (B0_, B1_, B2_, A1_, and A2_). The coefficients are configured by clicking the register bit labels or by entering a 24-bit hex-formatted value in its **Edit** box. For example, [Figure 12](#) shows coefficient B0 of Band 1.

The **Update Coefficients** button updates the EQ register map to reflect any changes that were made through the **7-Band Parametric Equalizer** dialog window.

Note: Coefficient changes made through this **EQ Registers** tab are not reflected on the **Block Diagram** tab or the **7-Band Parametric Equalizer** dialog window.

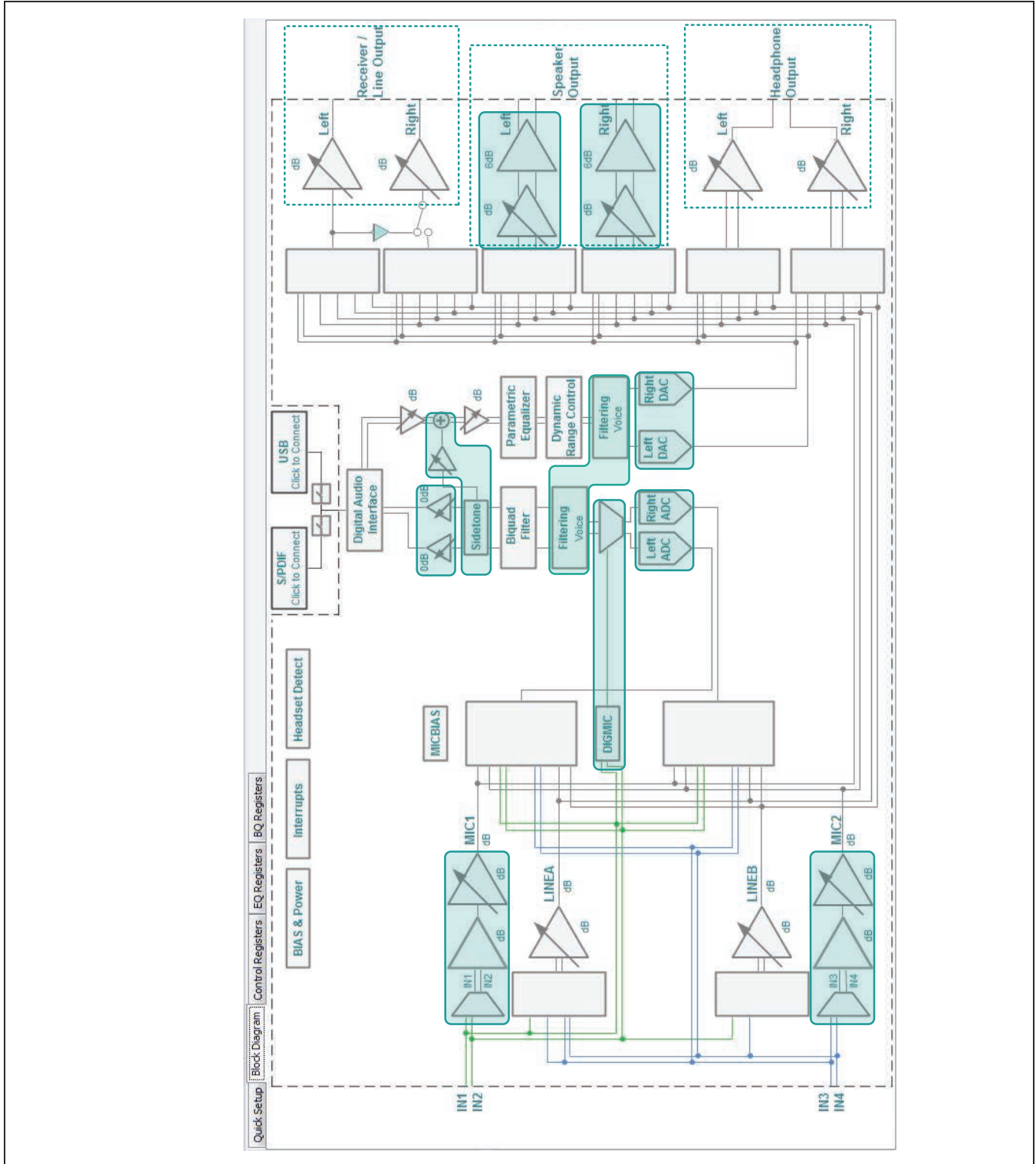

Figure 8. Diagram Blocks with Shared and/or Synchronized Dialog Windows

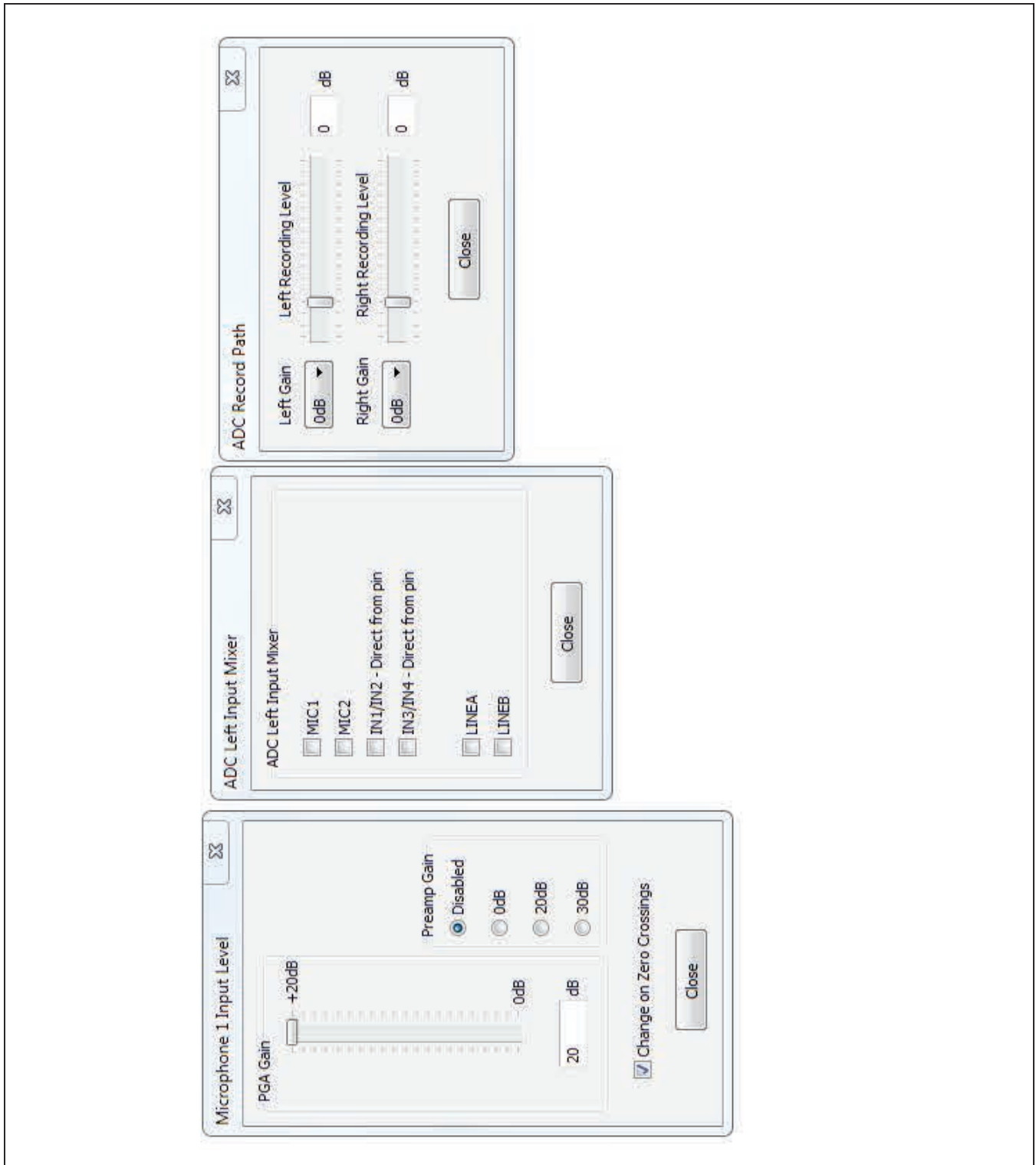

Figure 9. Dialog Windows

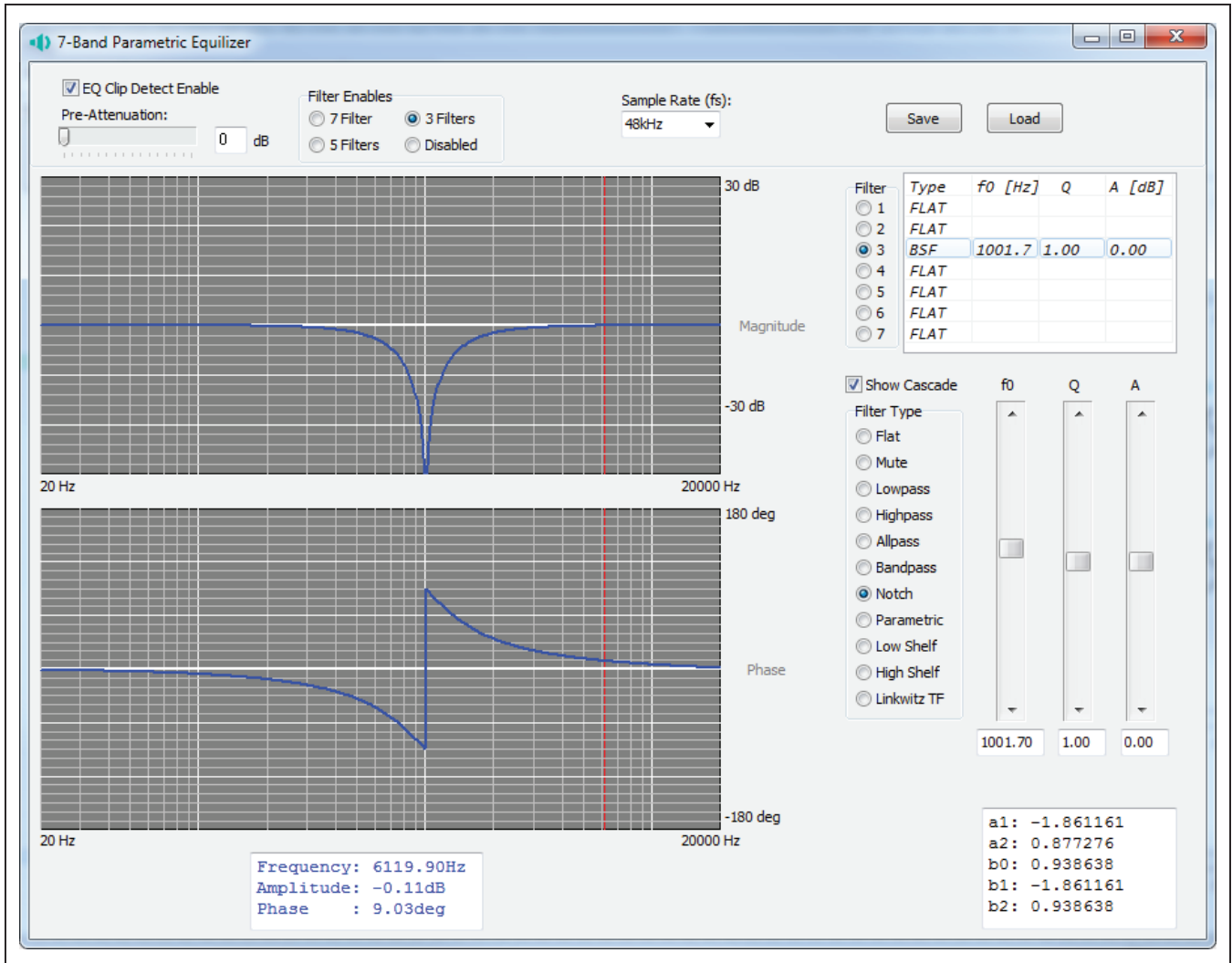

Figure 10. Biquad Filter Dialog Window

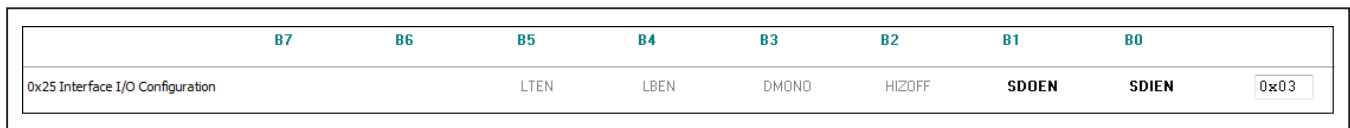

Figure 11. Register Tab Elements

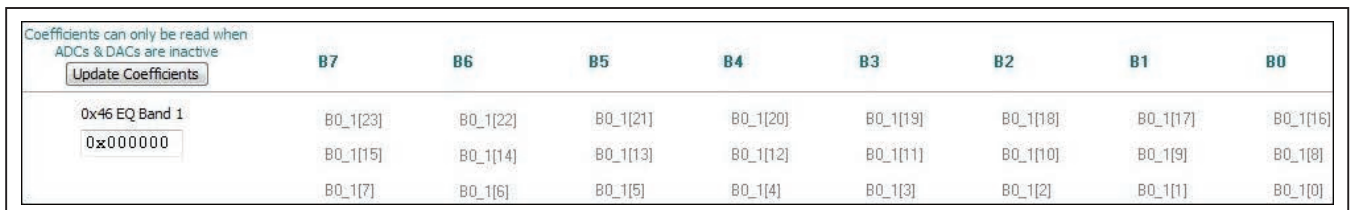

Figure 12. Coefficient (B0) of EQ Band 1

Biquad (BQ) Registers

The main use of the **BQ Registers** tab is to provide access to the raw data contained in the 15 BQ registers (0xAF–0xBD). The preferred method for configuring the device's biquad filter is through the **Biquad Filter** dialog window.

The BQ registers are divided into five coefficients (ADCB0, ADCB1, ADCB2, ADCA1, and ADCA2) that are configured by clicking the register bit labels or entering a 24-bit hex-formatted value in the coefficient's **Edit** box.

The **Update Coefficients** button updates the **BQ Registers** tab to reflect any changes that were made through the **Biquad Filter** dialog window.

Note: Coefficient changes made through this **BQ Registers** tab are not reflected on the **Block Diagram** tab or the **Biquad Filter** dialog window.

Menu Bar

All the **Menu** bar items are described in [Table 1](#). Additional information on a few of the menu items is provided in the following sections.

File

The software's save and load features are accessed from the **File** menu item. The save feature saves the data currently displayed on the **Control Registers** tab and **S/PDIF Transceiver** tab. The current state of the configurable GPIO pins is also saved to the configuration file. The data from the **EQ Registers** and **BQ Registers** tabs is saved if the filters are enabled.

A configuration file's main purpose is to capture the current state of the MAX98090's registers, as displayed on the register tabs. This feature makes it easy to program a device to a saved/known state and allows for the sharing of configuration files between users. The file and save features can still be used when an EV kit is not connected. This allows configuration files to be created and opened with out the hardware and further contributes to the sharing of configuration files. To facilitate file usage, use descriptive file names when saving configuration files.

Since the configuration file is automatically generated by the software, it is not meant to be manually formatted and doing so may cause file loading issues. To open a configuration file for viewing, use a plain text editor.

Select **File | Save Settings Ctrl+S** to create a configuration file. Data is saved as tab-delimited values and the file is saved with a .98090 extension.

To load a saved configuration file, select **File | Load Settings Ctrl+O**. Only writable registers are programmed with data from the loaded configuration file.

Connect Options

The **Connect Options** item is accessed from the **Options** menu. This menu item provides two methods for interfacing the MAX98090 EV kit hardware to the MAX98090 software. The simplest method (**MAXQ USB**) uses a standard male-to-male USB cable (A to mini-B) connection. A local PC, running the MAX98090 software, connects to the USB CONTROL port (J1) on the EV kit. This method uses the on-board MAXQ2000 microcontroller circuitry to communicate with the MAX98090 I²C-capable device.

The **TCP** option is used to setup an Internet connection between the EV kit and the software. To use this feature, additional hardware/software (not provided) are required. The additional tools would function as the communication medium between the Ethernet connection and the MAX98090's I²C bus. When using this option, the USB CONTROL port (J1) on the EV kit still needs to be powered, in order to supply the on-board LDOs.

Software Versions

The MAX98090 software works with both packaged versions (TQFN and WLP) of the MAX98090. Each version of the MAX98090 has its own unique EV kit. The WLP version is evaluated on the MAX98090EVKIT#WLP kit and the TQFN version is evaluated on the MAX98090EVKIT#TQFN kit. Once an EV kit is connected to the host PC and a connection is established with the software, the program automatically detects the device type and configures the GUI accordingly.

The **Software Versions** item from the **View** menu allows for the reconfiguring of the GUI. This is particularly useful when an EV kit is not connected and the user wants to generate a configuration file for a specific MAX98090 package. This feature can be used when an EV kit is connected to the software, but care must be taken since the software does not automatically revert the GUI back to the appropriate version. In this case, the user needs to manually select the version that matches the connected device or perform a Disconnect-then-Connect operation.

The main difference between the WLP and TQFN versions of the MAX98090 is the additional inputs (IN5 and IN6) available on the WLP version. This difference results in changes to the **Quick Setup**, **Block Diagram**, and **Control Registers** tabs. These differences are also discussed in the MAX98090 IC data sheet.

Detailed Hardware Description

The MAX98090 EV kit (TQFN) evaluates the TQFN package version of the MAX98090 audio codec and provides access to all analog and digital inputs/outputs

Table 1. Menu Bar Items

| MENU ITEM | DESCRIPTION |
|--|--|
| FILE | |
| Load Settings Ctrl+O | Loads a configuration file (as saved by the Save Settings option). |
| Save Settings Ctrl+S | Saves a configuration file containing the current device settings. |
| Exit | Closes the MAX98090 software. |
| VIEW | |
| Show S/PDIF Transceiver Registers | Toggles the visibility of the S/PDIF Transceiver register tab, allowing for more control of the on-board S/PDIF transceiver (U201). |
| Software Versions | |
| MAX98090 TQFN | Reconfigures the block diagram and register tabs for the selected device. |
| MAX98090 WLP | |
| OPTIONS | |
| Auto Connect | When selected, the software checks the connection status of the MAXQ2000 interface and the MAX98090 device approximately every second. If not connected, the software attempts to establish a connection. |
| Auto Read Status | When selected, the device's status registers will be read approximately every second. The Status panel and Control Registers tab are refreshed after each read. |
| Auto SHDN for Register Writes | When selected, the software will ensure that the MAX98090 is in shutdown before writing to certain registers. (See Table 90 of the MAX98090 IC data sheet for the registers that should only be programmed while the device is in shutdown.) |
| I²C Clock Speed | |
| 100kHz | Configures the clock speed of the I ² C interface. |
| 400kHz | |
| Configure MCLK Routing | Opens the MCLK Routing dialog window that is used to select a clock source for the MAX98090 master clock (MCLK) input. In order for this clock to drive the MAX98090 a shunt must be placed on pins 1-4 of header JU14. |
| Connect Options | Sets the interface method between the EV kit and MAX98090 software. |
| Cmod USB | MAX98090 EV kit interfaces to a local PC through its USB Control (J1) port. |
| TCP | MAX98090 EV kit interfaces to a remote PC via a TCP connection. Additional hardware setup required. |
| ACTIONS | |
| Read All Registers F4 | Reads all MAX98090 registers and updates the GUI. Also reads all of the S/PDIF transceiver (U201) registers. |
| Write All Registers F8 | Writes the data from the Edit boxes, on the Control Registers tab, to the MAX98090 device and updates the GUI. Also writes to the S/PDIF transceiver (U201) registers and updates all configurable GPIO pins. |
| Reset All Registers F12 | Resets the device according to the check box selections on the Reset dialog window. |
| HELP | |
| About | Pop-up window that provides information about the software. |

on the device. The EV kit also includes USB powered linear-dropout (LDO) regulators that allow the EV kit to be evaluated with a single external supply (+2.8V to +5.5V).

Integrated into the EV kit design are a stereo digital audio transceiver (U201) and a stereo audio DAC with USB interface (U200). The digital audio transceiver provides audio input and output via the on-board TOSLINK (SPDIFOUT and SPDIFIN) connectors and the USB audio DAC allows for audio input from the USB AUDIO port (J2).

In addition, the EV kit includes a MAXQ2000 microcontroller that facilitates evaluation by providing I²C, SPI, and GPIO interfaces, allowing the MAX98090 software to communicate with the devices on the EV kit.

Power Supplies

The EV kit requires a single 2.8V to 5.5V external supply, SPKVDD, to operate. All other MAX98090 supply inputs are powered from the J1 USB port. Jumpers JU1–JU4 (see [Table 2](#)) allow all MAX98090 supply inputs to be disconnected from USB power and connected to external supplies. In addition, jumpers JU1 and JU2 are used to configure the on-board voltage connected to DVDD and DVDDIO, respectively. See [Table 2](#) for jumper JU1–JU4 configuration options.

To perform supply current and power consumption measurements, use external supplies to power the MAX98090 IC supply inputs: HPVDD, AVDD, DVDD, and DVDDIO.

Jumper Selection

The EV kit includes 25 jumpers to adjust various hardware configuration options. [Table 2](#) describes all the jumpers available on the EV kit.

Master Clock (MCLK) Selection

Jumper JU14 selects which master clock (MCLK) source drives the MAX98090 IC. The available clock configurations are listed in [Table 3](#). When streaming audio through the on-board USB AUDIO port or S/PDIF connectors, the EV kit software automatically configures the U8 and U9 switches to route the appropriate clock signal to the MAX98090 MCLK input.

If an external audio source is used, choose either the on-board 13MHz oscillator or an external clock. To connect an external clock, remove the shunt from JU14 and connect the clock to pin-1.

I²S Audio I/O

The EV kit provides three methods for evaluating the MAX98090's digital audio interface (DAI). The first method is through the I²S header (JU15) and this provides the most direct connection to the MAX98090's DAI.

The two other methods involve streaming audio onto or off the EV kit. The USB AUDIO port (J2) is used to stream audio onto the EV kit. The SPDIFIN and SPDIFOUT optical connectors are used to stream audio onto or off the EV kit, respectively.

The USB and S/PDIF digital audio signals are switched onto the PCM bus through switches U10 and U11. The switches are automatically configured by the evaluation kit software, depending on which path has been enabled (USB or S/PDIF).

Note: All PCM digital audio is routed through the I²S header before routing to the MAX98090's DAI. This is true for the USB AUDIO input as well as for the S/PDIF I/O. See [Figure 13](#).

Digital Audio Interface Header (JU15)

Jumpers JU15 provides access to the MAX98090 digital audio interface (DAI). See [Table 4](#) for individual pin descriptions. Follow the below steps to configure JU15:

Direct connection of PCM digital audio:

- Remove the shunts from JU15 (place shunts on Position 1 for safekeeping).
- Connect the PCM signals/grounds to the corresponding Position 2 (Center) and Position 3 (Right) pins of JU15.

USB audio input or S/PDIF I/O:

- Install the four shunts between Position 2 and Position 3 of JU15
- For audio input, connect an audio output device to the USB AUDIO or SPDIFIN connector.
- For audio output, connect an audio input device to the SPDIFOUT connector.

Table 2. Jumper Configuration

| HEADER | SHUNT POSITION | DESCRIPTION |
|--------|----------------|--|
| JU1 | 1-2* | DVDD connected to +1.2V |
| | 2-3 | DVDD connected to +1.8V |
| | Open | DVDD externally supplied |
| JU2 | 1-2* | DVDDIO connected to +3.3V |
| | 2-3 | DVDDIO connected to +1.8V |
| | Open | DVDDIO externally supplied |
| JU3 | Installed* | AVDD connected to +1.8V |
| | Open | AVDD externally supplied |
| JU4 | Installed* | HPVDD connected to +1.8V |
| | Open | HPVDD externally supplied |
| JU5 | Installed | Connects JACKSNS to headphone jack, HP, for jack detection; ensure that a shunt is installed on JU27/JU6 or JU28/JU22 for proper jack detection. |
| | Open* | Disconnects JACKSNS from the headphone jack, HP |
| JU6 | Installed | Connects MICBIAS to the IN1 input through a 2.2kΩ resistor (for microphone input) |
| | Open* | Disconnects MICBIAS from the IN1 input |
| JU7 | Installed | Connects MICBIAS to the IN3 input through a 2.2kΩ resistor (for microphone input) |
| | Open* | Disconnects MICBIAS from the IN3 input |
| JU8 | Installed | Connects IN2 directly to ground for single ended operation |
| | Open* | Allows for differential operation |
| JU9 | Installed | Connects IN2 to ground through a 2.2kΩ resistor (used when IN1 is mic biased) |
| | Open* | Disconnects IN2 from ground |
| JU10 | Installed | Connects IN4 directly to ground for single ended operation |
| | Open* | Allows for differential operation |
| JU11 | Installed | Connects IN4 to ground through a 2.2kΩ (used when IN3 is mic biased) |
| | Open* | Disconnects IN4 from ground |
| JU12 | Installed | Connects the Digital Microphone data output to MAX98090 |
| | Open* | Disconnects the Digital Microphone data output from MAX98090 |
| JU13 | Installed | Connects the Digital Microphone clock to MAX98090 |
| | Open* | Disconnects the Digital Microphone clock to MAX98090 |
| JU14 | - | See Table 3 |
| JU15 | - | See Table 4 |
| JU16 | 2-3, 5-6* | Connects the on-board I ² C master to MAX98090 |
| | Open | Allows external control of MAX98090 |
| JU17 | Installed | Connects an 1800pF bypass capacitor to IN1 |
| | Open* | Removes the 1800pF bypass capacitor from IN1 |
| JU18 | Installed | Connects an 1800pF bypass capacitor to IN2 |
| | Open* | Removes the 1800pF bypass capacitor from IN2 |

Table 2. Jumper Configuration (continued)

| HEADER | SHUNT POSITION | DESCRIPTION |
|--------|----------------|--|
| JU19 | Installed | Connects an 1800pF bypass capacitor to IN3 |
| | Open* | Removes the 1800pF bypass capacitor from IN3 |
| JU20 | Installed | Connects an 1800pF bypass capacitor to IN4 |
| | Open* | Removes the 1800pF bypass capacitor from IN4 |
| JU21 | Installed | Enables SPKVDD voltage detection |
| | Open* | Disables SPKVDD voltage detection |
| JU22 | Installed | Connects IN1 to the headphone jack, HP (for microphone input) |
| | Open* | Disconnects IN1 from the headphone jack, HP |
| JU23 | Installed | Removes AC coupling capacitor, C66, from LOU _{TL} line output |
| | Open* | Enables AC coupling capacitor, C66, to LOU _{TL} line output |
| JU24 | Installed | Disables AC coupling capacitor, C67, from LOU _{TR} line output |
| | Open* | Enables AC coupling capacitor, C67, to LOU _{TR} line output |
| JU100 | Installed* | Connects the MAX98090 interrupt output (\overline{IRQ}) to the on-board microcontroller |
| | Open | Disconnects the MAX98090 interrupt output (\overline{IRQ}) from the on-board microcontroller |

*Default position.

Table 3. Master Clock Source Configuration (JU14)

| SHUNT POSITION | CLOCK SOURCE |
|----------------|--------------------------------|
| 1-2 | Disabled |
| 1-3 | 13MHz oscillator |
| 1-4* | Software-selected clock source |

*Default position.

Table 4. DAI Header (JU15)

| JU15 | | |
|-------------------|-------------------------|--------------------|
| POSITION 1 (LEFT) | POSITION 2 (CENTER) | POSITION 3 (RIGHT) |
| GND | CODEC_BCLK | I2S_BCLK |
| GND | CODEC_LRCLK | I2S_LRCLK |
| GND | CODEC_SDIN | I2S_DAC |
| GND | CODEC_SDOU _T | I2S_ADC |

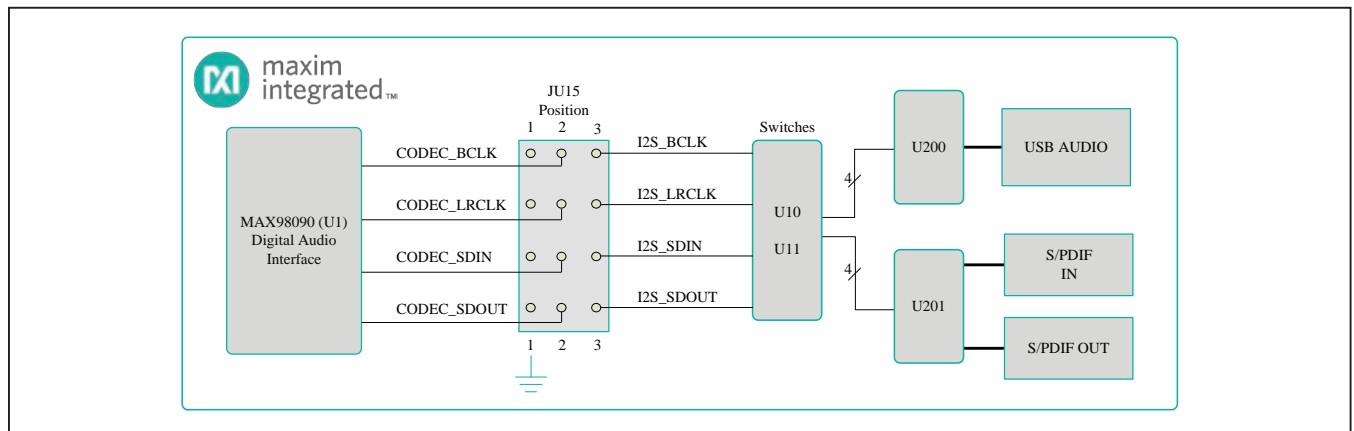

Figure 13. I²S Routing

S/PDIF Transceiver

The S/PDIF transceiver (U201) serves as a format converter between I²S and S/PDIF. Use this device to send and receive digital audio over the optical connectors (SPDIFIN, SPDIFOUT).

When receiving S/PDIF data, the transceiver outputs a recovered master clock that is exactly 256 x f_s, where f_s is the sample rate. This clock signal can be used to clock the MAX98090.

When transmitting S/PDIF data, the transceiver requires a master-clock input and if data is also being received, it uses the data to generate its own master clock.

If S/PDIF data is not being received, the transceiver generates a master clock based on the LRCLK signal being output by the MAX98090. For proper transmit-only operation, the S/PDIF transceiver must be configured in master mode.

The S/PDIF transceiver is controlled through the SPI interface of the on-board MAXQ2000 microcontroller. See the [Control Interface](#) section of this data sheet.

USB Audio

The Audio DAC with USB interface (U200) accepts an audio stream from a PC, connected to the USB AUDIO port (J2), and converts it to I²S data. The USB audio DAC generates a master-clock signal that can be used to clock the MAX98090. The clock signal is 256 x f_s.

The USB audio DAC supports standard class drivers that are included with most operating systems. As a result, no

drivers are required for this device and it will appear as a sound card in the PC. This allows for audio playback from the PC through the MAX98090 audio CODEC.

Analog Inputs

The MAX98090 analog input pairs (IN1/IN2, IN3/IN4) can be configured for microphone input, single-ended input, or differential input. These input connections are made through the provided RCA connectors or PCB pads (IN1-IN4). In addition, the IN1/IN2 inputs can be connected to the 3.5mm audio jack (HP) for single-ended microphone input from a headset. [Table 5](#) lists the configuration headers that are associated with each input pair. See the specific input sections for configuration details.

Single-Ended and Differential Inputs

The two analog input pairs are configured for single-ended or differential line input by configuring the associated input headers (as listed in [Table 5](#)). For single-ended inputs, the input header configuration is independent of the input type. For differential inputs the header configuration is different for microphone inputs that are powered by the MAX98090 MICBIAS output. See [Table 6](#).

Analog Microphone

When using the analog input pairs for microphone input the MAX98090 microphone bias (MICBIAS) output can be used to power the connected microphone. The MICBIAS output is connected to the IN1 or IN3 inputs through the input’s associated MICBIAS header. See [Table 7](#).

Table 5. Analog Input Headers

| INPUT | SINGLE-ENDED/ DIFFERENTIAL HEADER | DIFFERENTIAL MICROPHONE HEADER | MICBIAS HEADER |
|----------|--------------------------------------|-----------------------------------|----------------|
| IN1/IN2* | JU8 | JU9 | JU6 |
| IN3/IN4 | JU10 | JU11 | JU7 |

*The microphone input from the HP headset is routed to IN1.

Table 6. Analog Input Header Configuration

| INPUT | SINGLE-ENDED | DIFFERENTIAL | DIFFERENTIAL MICROPHONE(WITHMICBIAS) |
|---------|--------------|--------------------------|---|
| IN1/IN2 | JU8 = On | JU8 = Off JU9 = Off | JU8 = Off JU9 = On |
| IN3/IN4 | JU10 = On | JU10 = Off JU11 = Off | JU10 = Off JU11 = On |

Digital Microphone

The EV kit includes an on-board digital microphone (U3) for evaluation of the MAX98090’s digital microphone interface. The digital microphone interface is enabled and configured through the MAX98090 software. An additional digital microphone footprint (U2) is provided to exercise the device’s capability of interfacing with up to two digital microphones.

Install shunts on jumpers JU12 and JU13 to connect the digital microphone(s) to the MAX98090 device. Refer to the MAX98090 IC data sheet for additional details.

Jack Detection

The MAX98090’s flexible, software configurable jack detection interface is used to detect the presence or absence of a headphone/headset connected to the HP jack. To provide jack detection on the HP jack, install a shunt on header JU5.

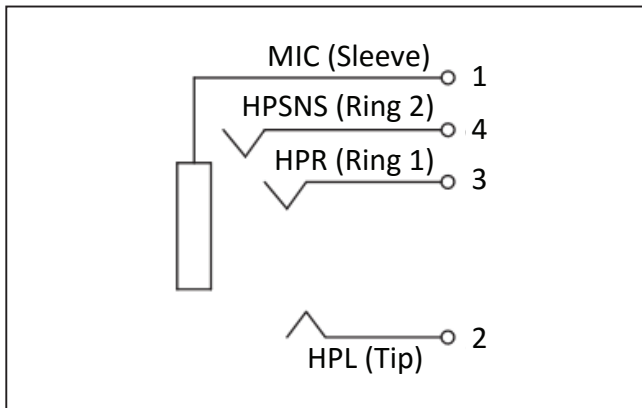

Figure 14. Headphone Jack

Outputs

The EV kit provides connections for each of the three analog outputs. Table 8 lists the outputs and their available connections.

Headphone

The MAX98090 stereo headphone output (HPR/HPL) is routed to the on-board 3.5mm audio jack (HP). The HP jack also allows for a headset connection, with the microphone input (MIC) connected to IN1. See the Analog Inputs section for input configuration options.

Stereo Class D Speaker Amplifier

The MAX98090 integrates a filterless Class D stereo amplifier. In systems with short speaker traces, the stereo speaker outputs (SPKLP/SPKLN and SPKRP/SPKRN test points) can be connected directly to the speaker loads. Although this amplifier is designed to operate completely filterless, the EV kit does provide stuffing options for two types of output filters.

When long speaker cables are used, a ferrite bead plus capacitor filter can be installed to prevent excessive EMI radiation. Although it is best to choose filter components based on EMI test results, the combination of a 680pF capacitor (C48–C51) with the Murata BLM18SG331TN1 ferrite bead (FB1–FB4) generally works well. With this configuration, connect the speaker loads to the SPKLP/SPKLN and SPKRP/SPKRN test points.

To allow analysis of the audio output with an oscilloscope, or an analyzer not designed to accept Class D switching waveforms, populate L1–L4 with the included 22µH inductors and make connections, to external equipment or speakers, at FSPKLP/FSPKLN and FSPKRP/FSPKRN.

Table 7. MICBIAS Connection

| MICROPHONE CONNECTION | MICBIAS CONNECTED | MICBIAS DISCONNECTED |
|-----------------------|-------------------|----------------------|
| IN1 | JU6 = On | JU6 = Off |
| IN3 | JU7 = On | JU7 = Off |

Table 8. Analog Outputs

| OUTPUT | CONNECTIONS |
|-------------------|--|
| Headphone | 3.5mm audio jack (HP) |
| Speaker | Unfiltered (SPK_P/SPK_N) and filtered (FSPK_P/FSPK_N) connection options |
| Receiver/Line-Out | RCA connectors (LOUTL and LOUTR) |

The LC filter is designed to work best with an 8Ω load. Do not connect the load to the unfiltered SPKLP/SPKLN and SPKRP/SPKRN outputs when L1–L4 are installed.

Receiver/Line Output

The MAX98090 receiver/line output can be configured either as a differential receiver/earpiece output or as a stereo-single ended line output. The receiver/line outputs are routed, through AC-coupling capacitors, to the LOU_{TL} and LOU_{TR} RCA connectors. The AC-coupling capacitors can be shorted (effectively removed from the signal path) by installing a shunt on JU23 and JU24.

Control Interface

The MAXQ2000 (U100) microcontroller circuitry is the bridge between the on-board interface-enabled devices and the EV kit software, running on a PC connected to the USB CONTROL port (J1). The EV kit uses the MAXQ2000's I²C, SPI, and GPIO interfaces.

I²C Interface

The MAXQ2000's I²C interface is routed to the MAX98090 device through jumper JU16, by installing shunts across pins 2-3 of each row (Table 9). When using an external I²C master, remove both shunts from JU16 and connect the external SDA and SCL signals to the position-2 pins of JU16. Ground connections can be made to the position-1 pins of JU16. Install pullup resistors at R15 and R16 if the external master does not include pullup resistors.

SPI Interface

The MAXQ2000 SPI interface is used to control the on-board S/PDIF transceiver (U201). In the MAX98090 software go to **View | Show S/PDIF Transceiver Registers** to activate the **S/PDIF Transceiver** tab.

GPIO Interface

Six of the MAXQ2000 general-purpose inputs/outputs (GPIOs) are used for either controlling or monitoring a specific on-board device/signal. Four of the GPIOs are used as general-purpose outputs and are automatically set/cleared based on configuration settings made through the MAX98090 EV kit software.

The other two are used as general-purpose inputs and are used to monitor a specific signal. The first general-purpose input, CODEC_IRQ, is tied to the MAX98090 interrupt (IRQ) output. This IRQ is monitored by the microcontroller and its state is reported in the **Status** group box on the left side of the software main window. This general-purpose input can be disconnected from the MAX98090's IRQ output by removing the shunt from jumper JU100.

The second general purpose input is used to detect the presence of the SPKVDD voltage. The software monitors this voltage input and reports whether it has been applied or not. As noted in the [Power Supplies](#) section, the SPKVDD voltage is required for proper device operation.

Table 9. I²C Header (JU16)

| JU16 | | |
|----------------------|------------------------|-----------------------|
| POSITION 1 (LEFT) | POSITION 2 (CENTER) | POSITION 3 (RIGHT) |
| GND | CODEC_SCL | SCL |
| GND | CODEC_SDA | SDA |

Ordering Information

| PART | TYPE |
|--------------------|--------|
| MAX98090EVKIT#TQFN | EV Kit |

#Denotes RoHS compliant.

MAX98090 (TQFN) Bill of Materials

| Item | Component Description | Qty | Reference Designator | Manufacturer | Manufacturer Part Number | Assembly Comments |
|------|--|-----|---|-----------------------|--------------------------|-------------------|
| 1 | 10uF ±20%, 6.3V X5R ceramic capacitor (0805) | 4 | C1, C3, C104, C202 | TDK | C2012X5R0J106M | |
| 2 | 1uF ±10%, 6.3V X5R ceramic capacitor (0402) | 17 | C2, C12, C13, C18, C24, C26, C27, C29-C35, C200, C201, C204 | TDK | C1005X5R0J105K | |
| 3 | 1800pF ±10%, 50V X7R ceramic capacitor (0402) | 4 | C4-C7 | Murata | GRM155R71H182K | |
| 4 | 10pF ±5%, 50V C0G ceramic capacitor (0402) | 2 | C8, C9 | Murata | GRM1555C1H100J | |
| 5 | 0.1uF ±10%, 10V X7R ceramic capacitor (0402) | 11 | C10, C40, C41, C60-C64, C203, C215, C216 | Kemet | C0402C104K8RAC | |
| 6 | 0.01uF ±10%, 50V X7R ceramic capacitor (0603) | 4 | C20, C43, C211, C212 | Murata | GRM188R71H103K | |
| 7 | 2.2uF ±10%, 6.3V X5R ceramic capacitor (0603) | 2 | C21, C22 | Murata | GRM188R60J225K | |
| 8 | 1uF ±20%, 6.3V X5R ceramic capacitor (0603) | 10 | C23, C25, C36, C37, C66, C67, C115-C118 | Taiyo Yuden | JMK107B7105MA | |
| 9 | 2.2uF ±20%, 6.3V X5R ceramic capacitor (0402) | 1 | C28 | Taiyo Yuden | JMK105BJ225MV | |
| 10 | 0.22uF ±10%, 6.3V XR5 ceramic capacitor (0402) | 10 | C38, C39, C52-C59 | TDK | C1005X5R0J224K | |
| 11 | OPEN, ceramic capacitor (0402) | 9 | C42, C44-C51 | | | |
| 12 | 10uF ±20%, 6.3V X5R ceramic capacitor (0603) | 1 | C65 | Murata | GRM188R60J106M | |
| 13 | 0.1uF ±10%, 50V X5R ceramic capacitor (0603) | 11 | C100, C101, C105, C107-C110, C113, C114, C209, C210 | TDK | C1608X5R1H104K | |
| 14 | 8pF ±0.5pF, 50V C0H ceramic capacitor (0402) | 4 | C102, C103, C207, C208 | Taiyo Yuden | UMK105CH080DV | |
| 15 | 33000pF ±10%, 25V X7R ceramic capacitor (0603) | 1 | C106 | Murata | GRM188R71E333K | |
| 16 | 18pF ±5%, 50V C0G ceramic capacitor (0603) | 2 | C111, C112 | TDK | C1608COG1H180J | |
| 17 | 47uF ±20%, 6.3V X5R ceramic capacitor (1206) | 2 | C205, C206 | Murata | GRM31CR60J476M | |
| 18 | 0.47uF ±10%, 6.3V X5R ceramic capacitor (0603) | 1 | C213 | Murata | GRM188R60J474K | |
| 19 | 47000pF ±10%, 25V X7R ceramic capacitor (0603) | 1 | C214 | Murata | GRM188R71E473K | |
| 20 | LED, yellow (0603) | 1 | D100 | Lite-On | LTST-C190YKT | |
| 21 | LED, red (0603) | 1 | D101 | Lite-On | LTST-C190CKT | |
| 22 | Ferrite bead (0603) | 2 | FB100, FB200 | Murata | BLM18PG221SN1 | |
| 23 | 0 Ohms ±5% resistor (0603) | 4 | FB1-FB4 | | | |
| 24 | 0 Ohms ±5% resistor (0402) | 2 | FB5, FB6 | | | |
| 25 | Ferrite bead (0402) | 4 | FB7-FB10 | Murata | BLM15HD182SN1 | |
| 26 | 3.5mm stereo headphone jack, 4 positions | 1 | HP | CUI Inc. | SJ-43514-SMT | |
| 27 | Buss Wire, 20G plated solid copper 0.25 inch U-shape wire loop | 22 | IN_1, IN_2, IN_3, IN_4, JACKSENSE, RCVPL/LOUTL, RCVN/LOUTR, GND, FSPKLP, FSPKLN, FSPKRP, FSPKRN, GND, DVDD, GND, DVDDIO, AVDD, GND, GND, HPVDD, SPKVDD, GND | Weico Wire | 9020 Buss | |
| 28 | RCA jack, PC mount, non-switched (red) | 6 | IN1, IN2, IN3, IN4, LOU1L, LOU1R | Kobiconn | 161-0096-E | |
| 29 | Test point "Miniature" 40mil drill size (red) | 14 | INA+, INB+, BCLK, LRCLK, SDIN, SDOUT, /IRQI, MCLK, OUTA, OUTB, IN1_DIR, IN2_DIR, IN3_DIR, IN4_DIR | Keystone | 5000 | |
| 30 | USB Mini B receptacle | 2 | J1, J2 | Hirose Electric | UX60A-MB-5ST | |
| 31 | 3-pin header, 0.1in centers | 2 | JU1, JU2 | Sullins | PEC36SAAN | cut to fit |
| 32 | 2-pin header, 0.1in centers | 20 | JU3-JU13, JU17-JU24, JU100 | Sullins | PEC36SAAN | cut to fit |
| 33 | 4-pin header, 0.1in centers | 1 | JU14 | Sullins | PEC36SAAN | cut to fit |
| 34 | 12-pin header (3x4), 0.1in centers | 1 | JU15 | Sullins | PEC36DAAN | cut to fit |
| 35 | 6-pin (2x3) header, 0.1in centers | 1 | JU16 | Sullins | PEC36DAAN | cut to fit |
| 36 | Open, inductors (6.2mm x 6.3mm) | 4 | L1-L4 | Toko | #A916CY-220M | |
| 37 | Ferrite bead, 47uH 220mA (1812) | 1 | L200 | Murata | LQH43MN470J03L | |
| 38 | MOSFET, -20V, -2.4A, P-channel (SuperSOT-3) | 1 | P100 | Fairchild | FDN304P | Top mark 304 |
| 38 | MOSFET, -20V, -2.4A, P-channel (SuperSOT-3) | 1 | P100 | Fairchild | FDN304PZ | Top mark 04Z |
| 39 | MOSFET, N-channel (SOT-23) | 1 | Q1 | Central Semiconductor | 2N7002 | |
| 40 | 0 Ohms ±5% Resistor (0402) | 13 | R1, R2, R9-R13, R38-R41, R111, R207 | | | |
| 41 | 1M Ohms ±5% Resistor (0603) | 2 | R3, R203 | | | |
| 42 | 10K Ohms ±5% Resistor (0603) | 2 | R4, R107 | | | |
| 43 | 10K Ohms ±5% Resistor (0402) | 3 | R5, R7, R8 | | | |
| 44 | OPEN, resistor (0402) | 4 | R6, R15, R16, R19 | | | |
| 45 | 2.2K Ohms ±5% Resistor (0402) | 4 | R14, R17, R18, R37 | | | |
| 46 | 22 Ohms ±5% Resistor (0402) | 6 | R21-R24, R200, R201 | | | |

MAX98090 (TQFN) Bill of Materials (continued)

| Item | Component Description | Qty | Reference Designator | Manufacturer | Manufacturer Part Number | Assembly Comments |
|------|--|-----|------------------------------------|-----------------------|--------------------------|-------------------|
| 47 | 100 Ohms ±5% Resistor (0603) | 4 | R25-R28 | | | |
| 48 | 1.5K Ohms ±5% Resistor (0603) | 5 | R100, R101, R104, R202, R204 | | | |
| 49 | 27 Ohms ±5% Resistor (0603) | 2 | R102, R103 | | | |
| 50 | 470 Ohms ±5% Resistor (0603) | 1 | R105 | | | |
| 51 | 2.2K Ohms ±5% Resistor (0603) | 1 | R106 | | | |
| 52 | 220 Ohms ±5% Resistor (0603) | 2 | R108, R110 | | | |
| 53 | 1K Ohms ±5% Resistor (0603) | 1 | R109 | | | |
| 54 | 47K Ohms ±5% Resistor (0603) | 1 | R205 | | | |
| 55 | 402 Ohms ±1% Resistor (0603) | 1 | R206 | | | |
| 56 | Digital Audio optical transmitter | 1 | SPDIFOUT | Everlight Electronics | PLT133/T9 | |
| 57 | Digital audio optical receiver | 1 | SPDIFIN | Everlight Electronics | PLR135/T9 | |
| 58 | Test point "Multipurpose" 63mil drill size (red) | 4 | SPKLP, SPKRP, HPR, HPL | Keystone | 5010 | |
| 59 | Test point "Multipurpose" 63mil drill size (black) | 6 | SPKLN, SPKRN, GND, GND, GND, HPGND | Keystone | 5011 | |
| 60 | Stereo Audio Codec (40 TQFN) | 1 | U1 | MAXIM | MAX98090AETL+ | |
| 61 | OPEN, digital microphone (6 LGA) | 1 | U2 | Knowles Acoustics | SPM0405HD4H | |
| 62 | Digital microphone (6 LGA) | 1 | U3 | Knowles Acoustics | SPM0423HD4H-WB | DO NOT WASH |
| 62 | Digital microphone (6 LGA) | 1 | U3 | Knowles Acoustics | SPM0423HE4H-WB | DO NOT WASH |
| 63 | OPEN, Dual Rail-to-Rail Op Amps (8 uMAX) | 1 | U4 | MAXIM | MAX4252EUA+ | |
| 64 | 1.8V Low noise linear regulator (5 SOT23) | 1 | U5 | MAXIM | MAX8887EZK18+ | Topmark: ADPX |
| 65 | 300mA LDO regulator (SOT23-6) | 1 | U6 | MAXIM | MAX1963AETZ120+ | |
| 66 | 3.3V Low noise linear regulator (5 SC70) | 2 | U7, U104 | MAXIM | MAX8511EXK33+ | Topmark: AEI |
| 67 | Dual SPDT switch (10 uDFN) | 4 | U8-U11 | MAXIM | MAX4906ELB+ | |
| 68 | Low Power Microcontroller (56 TQFN) | 1 | U100 | MAXIM | MAXQ2000-RBX+ | |
| 69 | USB to serial UART interface (32 pin QFN) | 1 | U101 | FTDI | FT232BQ | |
| 70 | 3-wire EEPROM, Type 93C46 (SOIC-8) | 1 | U102 | Atmel | AT93C46EN-SH-B | |
| 71 | 2.5V Low noise linear regulator (5 SC70) | 1 | U103 | MAXIM | MAX8511EXK25+ | Topmark: ADV |
| 72 | Stereo audio DAC with USB interface (32 TQFP) | 1 | U200 | TI | PCM2707PJT | |
| 73 | Digital audio transceiver (28 SO) | 1 | U201 | Cirrus Logic | CS8427-CSZ | |
| 74 | 13Mhz Clock oscillator (2.5mm x 2.0mm) | 1 | Y1 | ECS Inc | ECS-2033-130-BN | |
| 75 | 6MHz crystal | 1 | Y100 | Hong Kong X'tals | SSL6000N1HK188F0-0 | |
| 76 | Crystal, 16MHz (3.2mm x 2.5mm) | 1 | Y101 | Kyocera | CX3225SB16000D0FLJZZ | |
| 77 | Crystal, 12MHz (3.2mm x 2.5mm) | 1 | Y200 | Kyocera | CX3225SB12000D0FLJZZ | |
| 78 | Shunt | 29 | | Kycon | SX1100-B | |
| 79 | PCB | 1 | MAX98090 TQFN Evaluation Kit | | | |
| 1 | Cable, USB high-speed A-to-mini B | 2 | | Assmann Electric | AK672M2-2-R | |
| 2 | Inductor, 22uH, 1A (6.2mm x 6.3mm) | 4 | L1-L4 | Toko | #A916CY-220M | |

MAX98090 Schematics (continued)

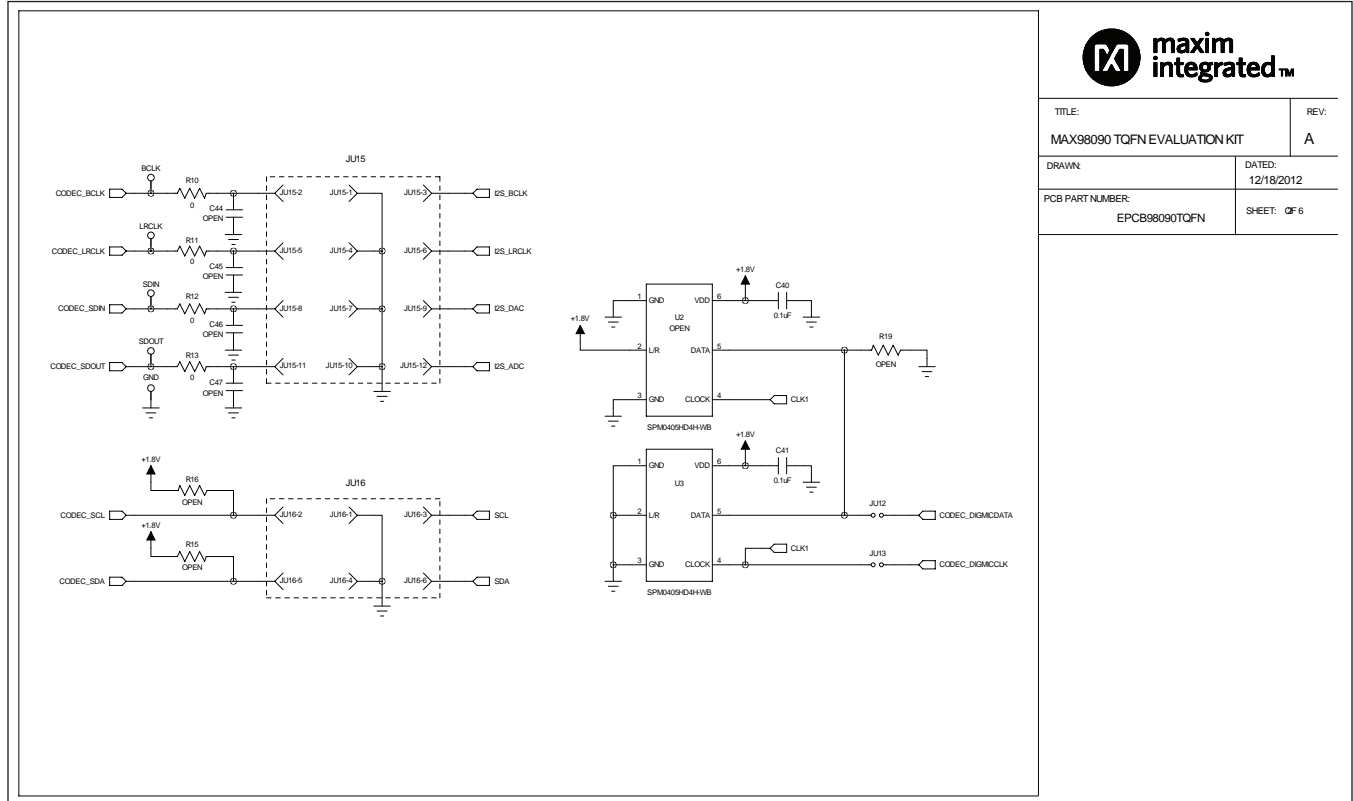

| | | |
|--|----------------------|-----------|
| TITLE: MAX98090 TQFN EVALUATION KIT | | REV: A |
| DRAWN: | DATED: 12/18/2012 | |
| PCB PART NUMBER: EPCB98090TQFN | SHEET: OF 6 | |

MAX98090 Schematics (continued)

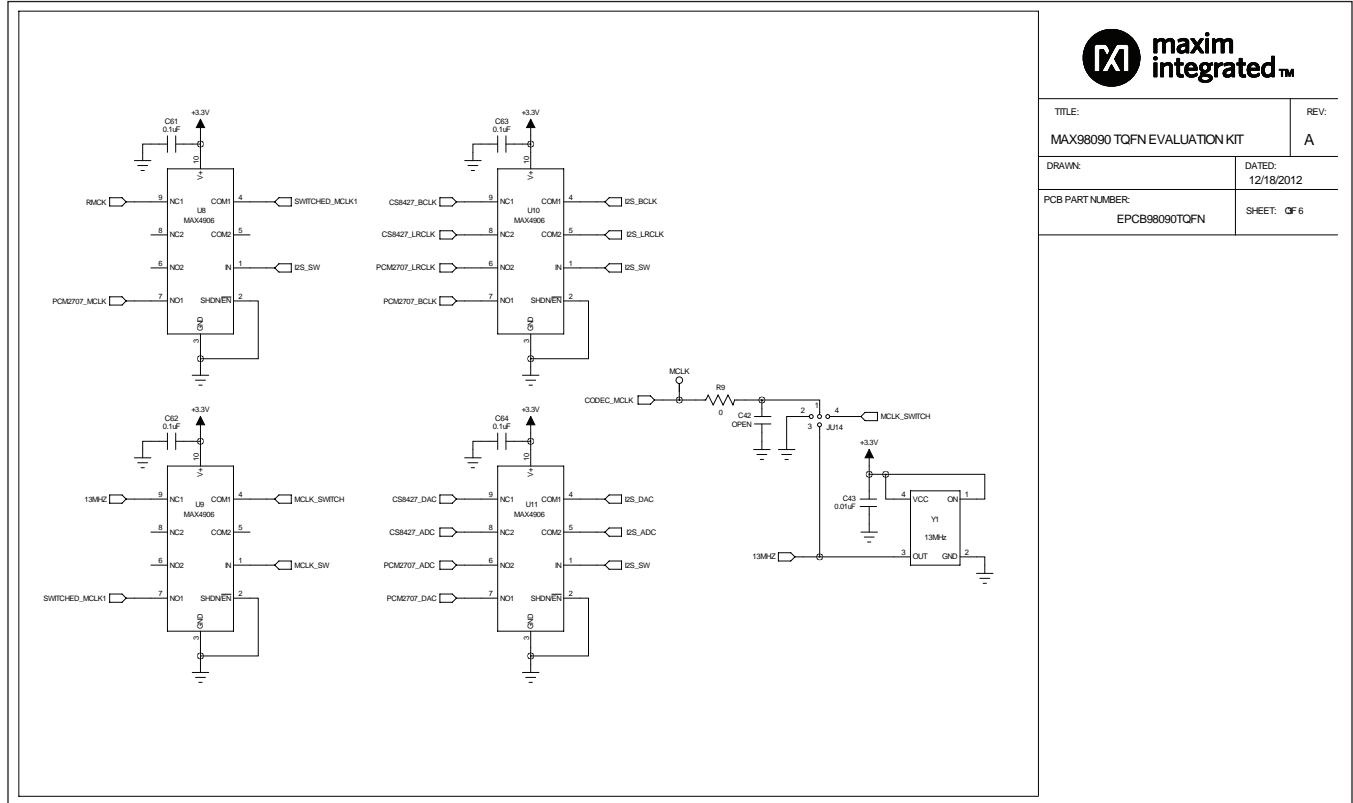

| | | |
|--|--|----------------------|
| TITLE: MAX98090 TQFN EVALUATION KIT | | REV: A |
| DRAWN: | | DATED: 12/18/2012 |
| PCB PART NUMBER: EPCB98090TQFN | | SHEET: OF 6 |

MAX98090 Schematics (continued)

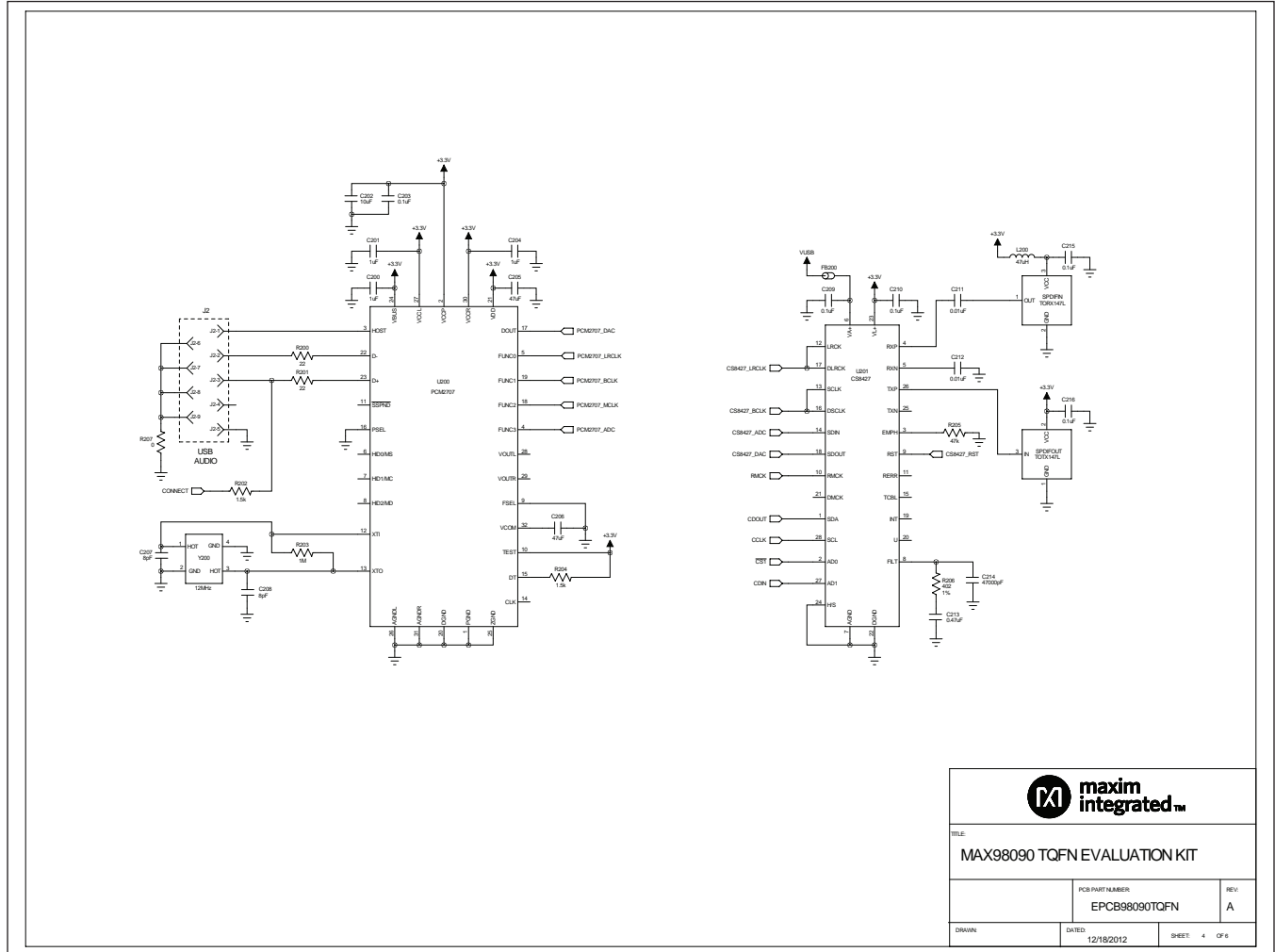

| | | |
|--|---------------------|--------------|
| maxim integrated™ | | |
| TITLE: MAX98090 TQFN EVALUATION KIT | | |
| PCB PART NUMBER EPCB98090TQFN | REV. A | |
| DRAWN | DATED 12/18/2012 | SHEET 4 OF 6 |

MAX98090 Schematics (continued)

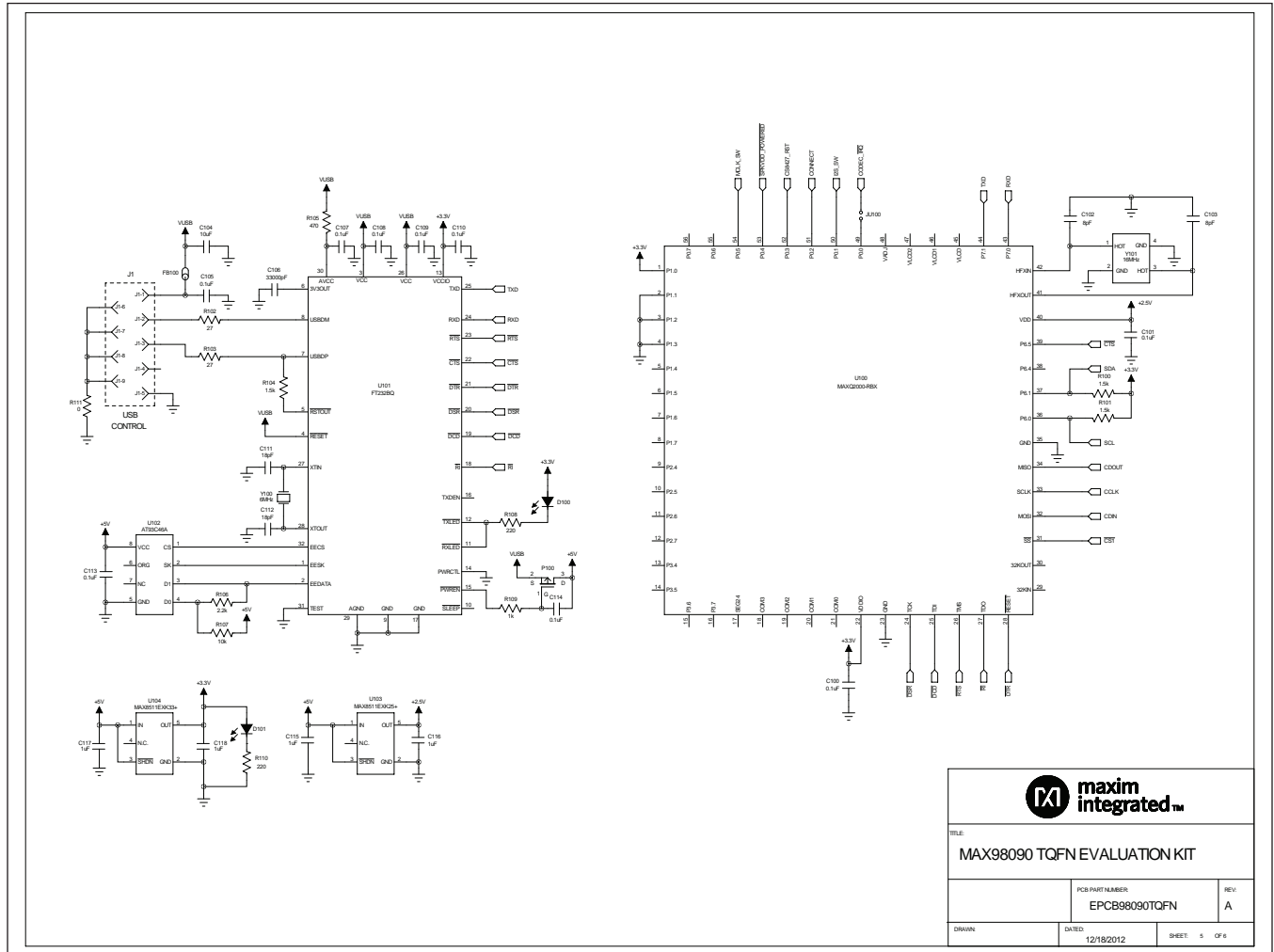

MAX98090 Schematics (continued)

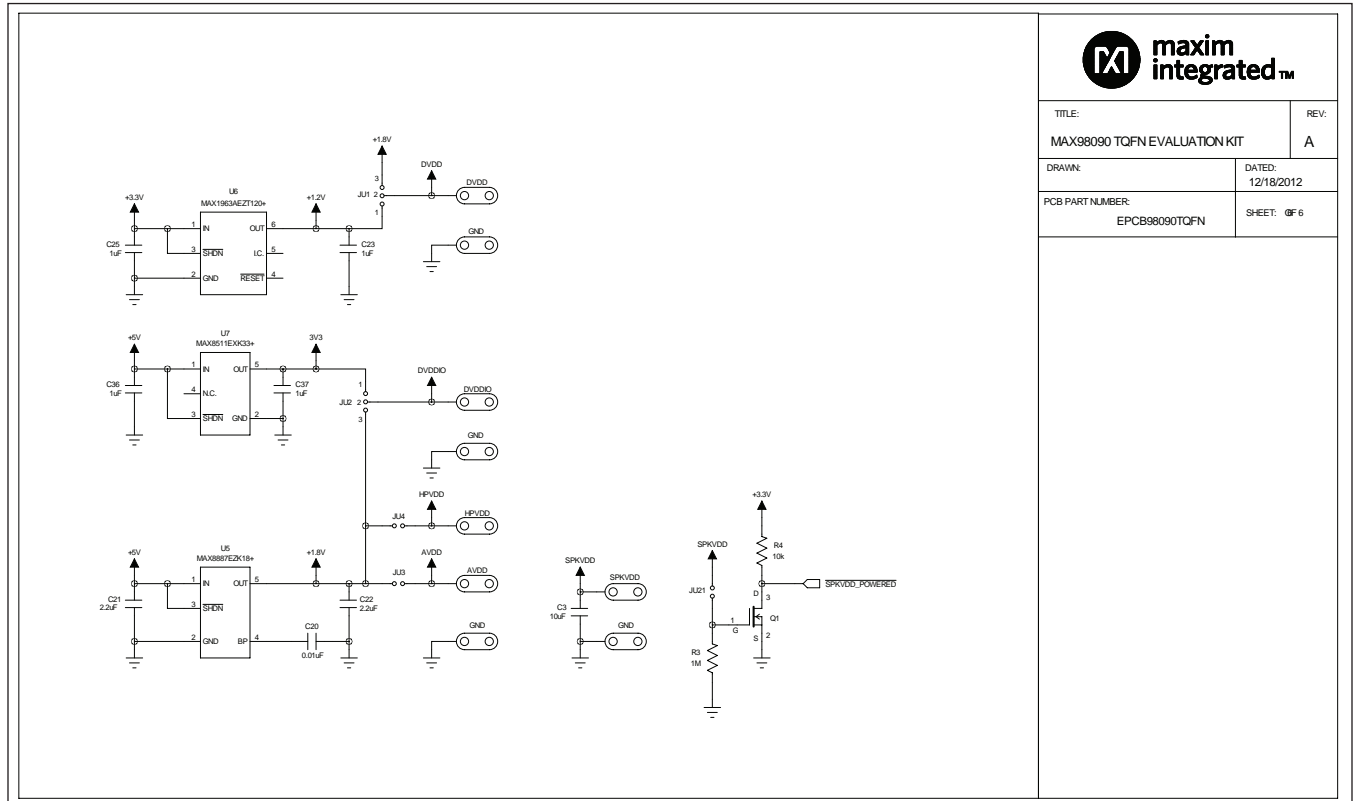

| | | |
|--|----------------------|-------------|
| TITLE: MAX98090 TQFN EVALUATION KIT | | REV: A |
| DRAWN: | DATED: 12/18/2012 | |
| PCB PART NUMBER: EPCB98090TQFN | | SHEET: 0F 6 |

MAX98090 Schematics (continued)

| | | |
|--|--|----------------------|
| | | |
| | TITLE: MAX98090 TQFN EVALUATION KIT | REV: A |
| | DRAWN: | DATED: 12/18/2012 |
| | PCB PART NUMBER: EPCB98090 | SHEET: OF 6 |

MAX98090 PCB Layout

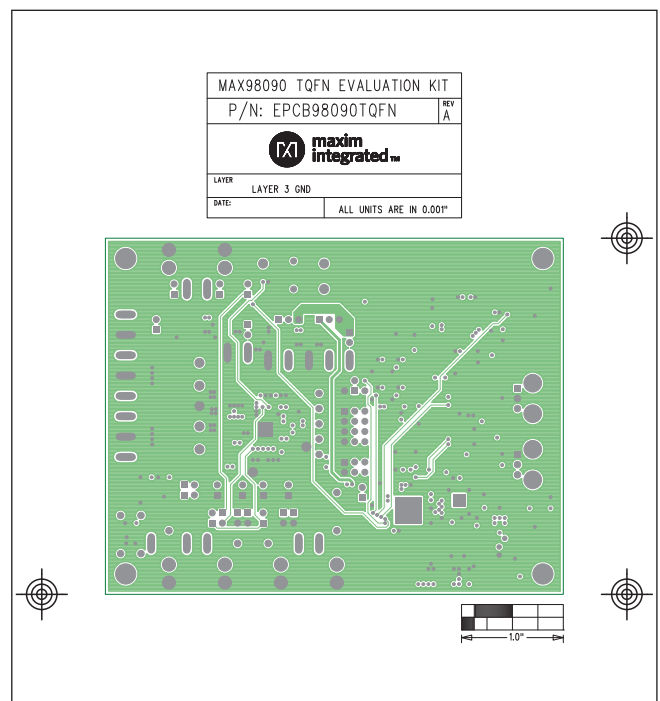
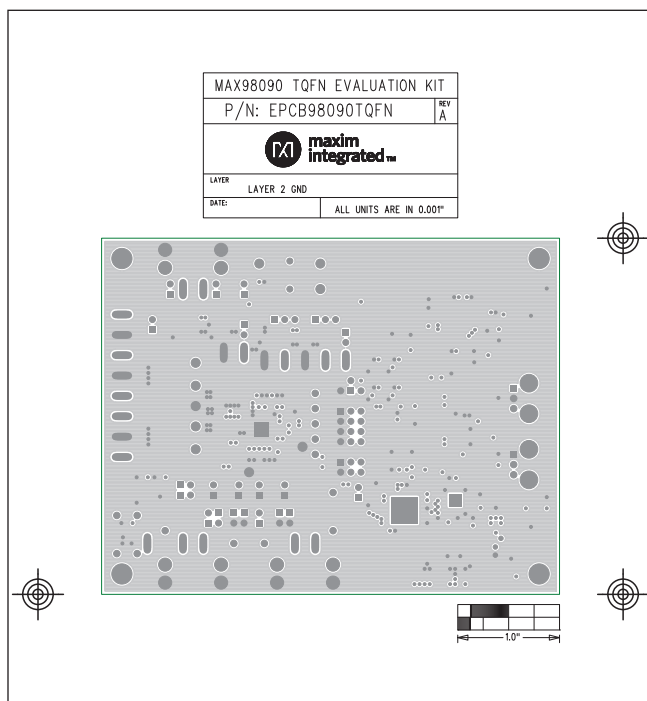
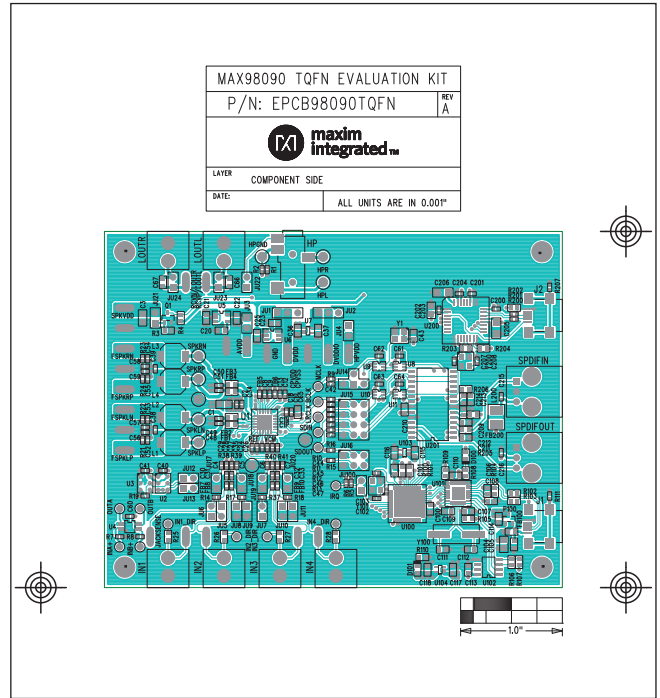
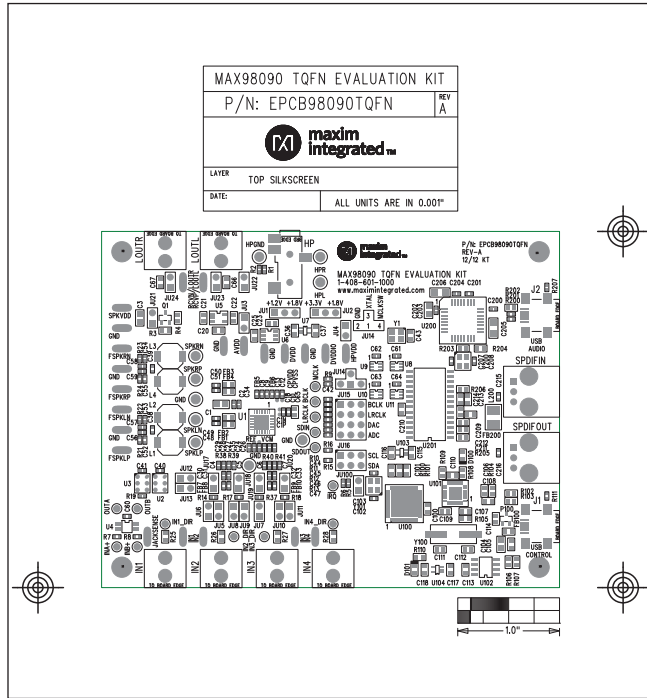

MAX98090 PCB Layout (continued)

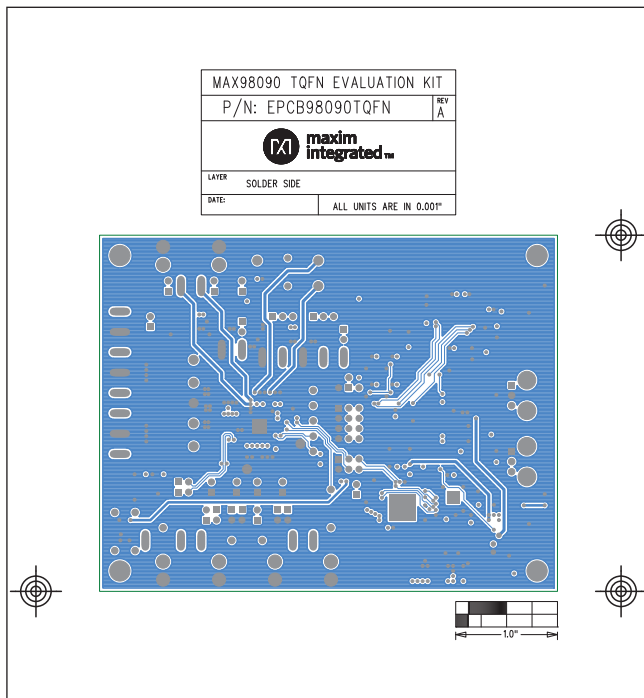
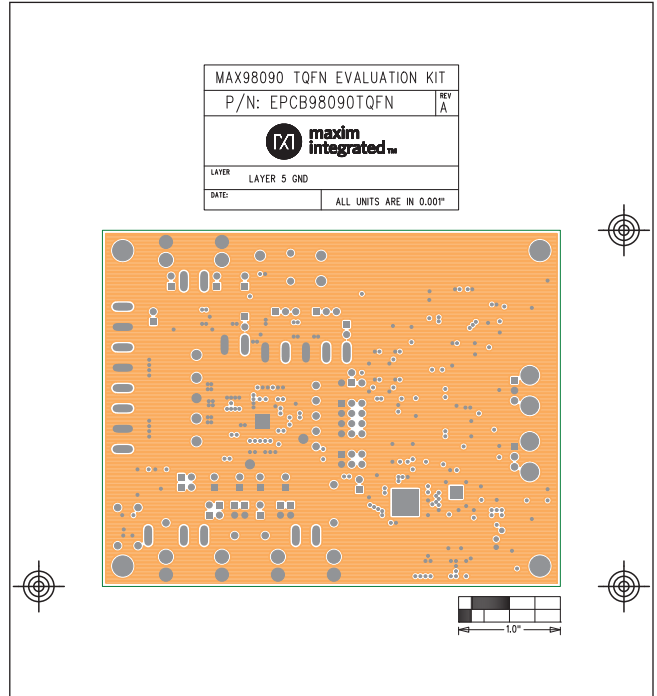
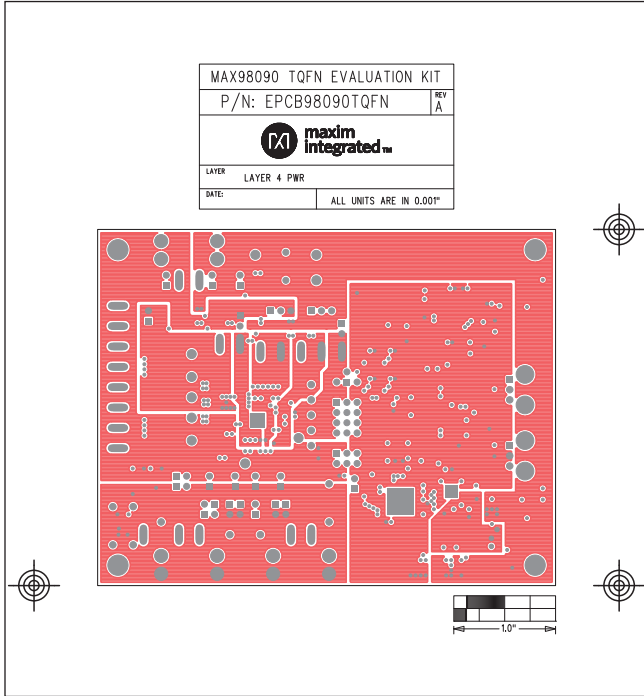

Revision History

| REVISION NUMBER | REVISION DATE | DESCRIPTION | PAGES CHANGED |
|-----------------|---------------|--|---------------|
| 0 | 2/15 | Initial release | — |
| 1 | 7/16 | Corrected jumper in <i>Master Clock (MCLK) Selection</i> section | 15 |

For pricing, delivery, and ordering information, please contact Maxim Direct at 1-888-629-4642, or visit Maxim Integrated's website at www.maximintegrated.com.

Maxim Integrated cannot assume responsibility for use of any circuitry other than circuitry entirely embodied in a Maxim Integrated product. No circuit patent licenses are implied. Maxim Integrated reserves the right to change the circuitry and specifications without notice at any time.