

5

4

3

2

1

Description: D-Sub Hood, Plastic, H andh HS Series, 25 Pins
 Part No: 40-9725H,HS
 (40-9725-HS is the same as 40-9725-H, but with metalized plating)

DRAWING NO.
 40-9725H,HS-CUST

REVISIONS

01 OFFICIAL RELEASE

12-19-12	G	M	M		ECO-12-0335
	Z	W	L		

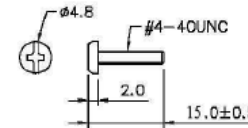
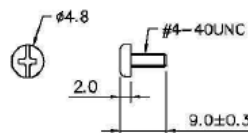
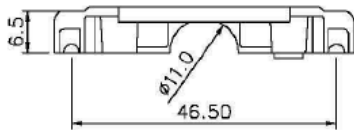
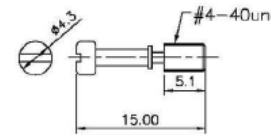
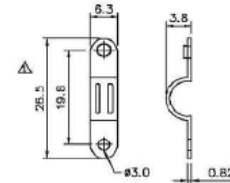
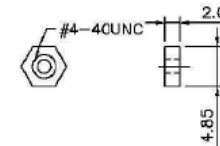
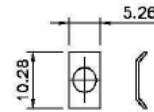
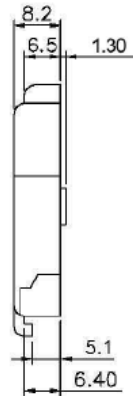
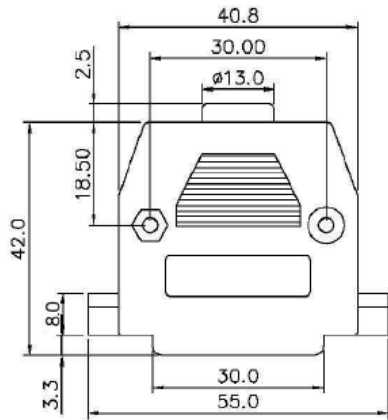

DIM OUTLINE

Hood Material: ABS,UL 94HB
 Color: Gray,Black,Ivory
 Screw Nut &Clip And Other ,Nickel Plated
 Plated:1Set/Bag

TOLERANCE UNLESS OTHERWISE SPECIFIED		DRAWN BY	DATE
		GARY.ZHG	12-19-12
DECIMALS	mm	CHECKED BY	DATE
X.X	+ 0.2	MONICA.W	12-19-12
X.XX	+ 0.1	APPROVED BY	DATE
X.XXX	+0.08	MA LIN	12-19-12
ANGLES	+ 0.5°	U/M	mm

CUSTOMER COPY



TITLE
 D-Sub Hood, Plastic, H Series, 25 Pins
 D-Sub Hood, Deluxe Metalized HS Series, 25 Pins

SHEET	DRAWING NO.	SIZE
1 OF 1	40-9725H,HS-CUST	A

THIS DRAWING WAS PRODUCED BY COMPUTER,
 DO NOT SCALE DRAWING OR UPDATE MANUALLY.

5

4

3

2

1